

CATALOGO ON - 2022

**on**

[www.attrezzaturearredi.it](http://www.attrezzaturearredi.it)

**ITALIA**

## **CATALOGO FOTOGRAFICO**

BANCHI ALIMENTARI - BANCHI PESCHERIA - BANCHI PASTICCERIA  
VETRINE CARRELLATE - MURALI SALUMI E LATTICINI - BANCHI SELF-SERVICE

# OUR PRODUCTS

## Serve-Over Counter

BANCO 1	6
BANCO 2	12
BANCO 3	18
BANCO 4	22
BANCO 5	28
BANCO 6	34
BANCO 7	40
BANCO 8	42
BANCO 9	44
VETRINA 1	48

## Self Service Display

MURALE 1	50
MURALE 2	56
MURALE 3	62
MURALE 4	68
MURALE 5	70
MURALE 6	72
SELF SERVICE 1	78
SELF SERVICE 2	82
SELF SERVICE 3	84

# OUR FUNCTIONALITY



Carne  
Meat  
Viande  
Fleisch



Bevande  
Drinks  
Boissons  
Getränke



Salumi - Formaggi  
Sausages - Cheese  
Charcuterie - Produits Laitiers  
Wurstwaren - Milchprodukte

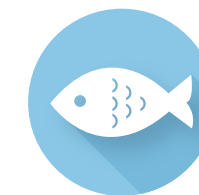

Pesce  
Fish  
Poisson  
Fisch



Gastronomia  
Deli  
Deli  
Deli



Frutta e Verdura  
Fruits and Vegetables  
Fruits et Legumes  
Obst und Gemüse



Pasticceria  
Pastry  
Pâtisserie  
Bäckerei



Sushi



Larghezza in cm.  
Width in cm.  
Largeur en cm.  
Breite in cm.



Lunghezza in cm.  
Length in cm.  
Longueur en cm.  
Länge in cm.

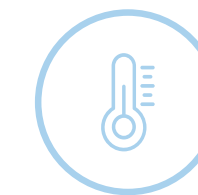

Classe climatica  
Climate class  
Classe climatique  
Klima-Klasse

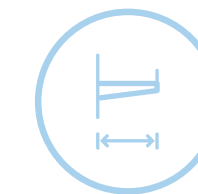

Profondità ripiano in cm.  
Shelf Depth in cm.  
Profondeur étagère en cm.  
Regal-Tiefe in cm.

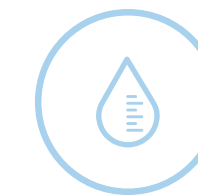

Capacità di carico in lt.  
Load capacity in lt.  
Capacité de charge en lt.  
Tragfähigkeit in lt.



# BANCO 1



Width in cm.

109



Length in cm.

150 · 200  
250 · 300



Climate class

3 M2  
25°C / u.r. 60%

## Stile, efficienza e qualità costruttiva.

Lo stile modernamente curato e l'ampia gamma di versioni, accessori e possibilità di personalizzazioni lo rendono ideale per soddisfare ogni esigenza e ogni layout nei concept stores più alla moda.



### Style, efficiency and quality of design.

With its search for modern design and wide range of versions, accessories and customization options, it is perfect to suit all the needs and layouts of modern concept stores.

### Style, efficacité et qualité de construction.

Grâce à son style très actuel et à sa vaste gamme de versions, d'accessoires et de possibilités de personnalisation, il devient idéal pour satisfaire toutes les exigences et tous les concepts stores les plus branchés.

### Stil, Effizienz und Verarbeitungsqualität.

Der moderne Stil und die große Vielfalt an Ausführungen, Zubehör und Anpassungsmöglichkeiten erlauben es, jeder Anforderung und jedem Layout in den angesagtesten Concept Stores gerecht zu werden.

D137 Urban Wood  
Version  
PL-1 / AA 90° / PC-5



# BANCO 1

White Oak  
Version  
PL-1 / AA 90° / PC-5 D136



1

Vetri apribili verso l'alto.

Lift up glass structure.

Structure avec verre s'ouvrant vers le haut.

Hebenverglasung Struktur.

2

Robusta struttura in alluminio

Solid aluminium structure.

Structure robuste en aluminium.

Stabile Aluminium-Struktur.

3

Illuminazione LED.

LED lighting.

Éclairage LED

LED-Beleuchtung

4

Zona esposizione in acciaio Inox.

Display area in stainless steel.

Zone d'exposition en acier inox.

Auslagefläche aus Edelstahl.

5

Piano lavoro standard in acciaio Inox.

Standard working plate in stainless steel.

Plan de travail standard en acier inox.

Standard Arbeitsplatte aus Edelstahl.

D107

Splendido  
Azzurro  
PL-2 / Terminal Cash / PF-2



Merce facile da posizionare con vetri frontali apribili.

The glass opens from the front to facilitate the display of goods.

Marchandise facile à exposer avec vitres frontales ouvrables.

Leicht zu positionierende Waren dank aufklappbarer Frontfenster.



Versione PC5 – Riscaldamento Bagno Maria

Version PC5 – Bain Marie warming method.

Version PC5 – Chauffage au bain-marie.

Version PC5 – Warmhalten im Wasserbad.

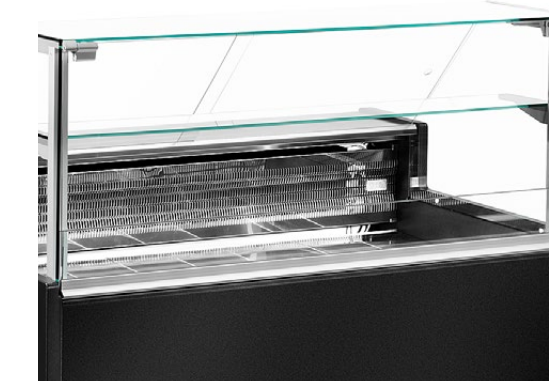

Vetro intermedio (optional con illuminazione a LED).

Intermediate glass (optional LED lighting).

Vitre intermédiaire (option avec éclairage à LED).

Zwischenregal aus Glas (optional mit LED-Beleuchtung).



## BANCO 1 Versions

Gray Black Optional

Colori spalla  
End colours  
Couleurs des côtés  
Farben für Rückwände

PL-1

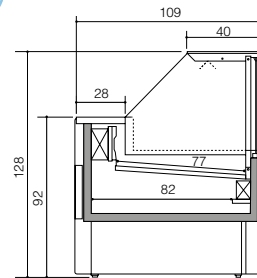

Statico con cella  
Static with cool storage  
Statique avec réserve  
Statisch mit Unterbaukuehlung

PL-2

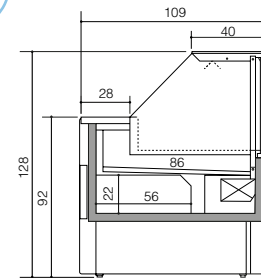

Ventilato con cella  
Ventilated with cool storage  
Ventiléé avec réserve  
Umluft mit Unterbaukuehlung

PO-3

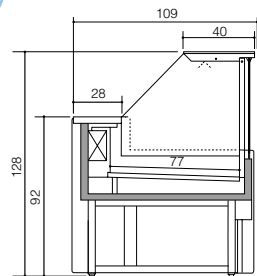

Statico senza cella  
Static without cool storage  
Statique sans réserve  
Statisch ohne Unterbaukuehlung

PO-4

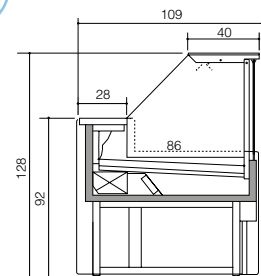

Ventilato senza cella  
Ventilated without cool storage  
Ventiléé sans réserve  
Umluft ohne Unterbaukuehlung

PC-5

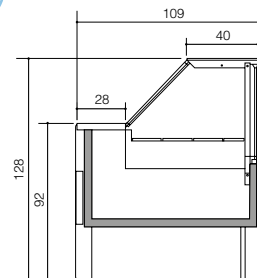

Riscaldamento - Bainmaria  
Heating - Bain Marie  
Chauffage - Bain-Marie  
Heisse Theke - Bain-Marie

PF-2

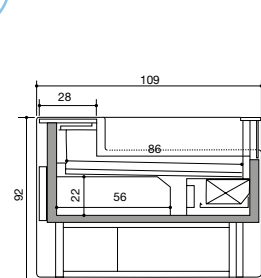

Self Service  
Ventilato con cella  
Ventilated with cool storage  
Ventiléé avec réserve  
Umluft mit Unterbaukuehlung

# Cold? Hot? Well, both.





# BANCO 2



Width in cm.

98



Length in cm.

150 · 200  
250 · 300  
350 · 400



Climate class

3 M2  
25°C / u.r. 60%

L'espositore alla moda per i locali più trendy.

Perfetto per creare ambienti di vendita dal gusto contemporaneo e internazionale, si distingue per gli alti contenuti tecnici e per il design di successo. È particolarmente adatto agli ambienti in cui è necessario massimizzare lo spazio espositivo.

A trendy display counter for trendy stores. Perfect to add a contemporary and international touch, stands out for its successful design and high technological content. Specifically indicated where the display area needs to be maximised.

Le présentoir à la mode pour les commerces les plus branchés. Parfait pour créer des espaces de vente au style contemporain et international, est caractérisé par ses contenus techniques élevés et son design très apprécié. Il s'adapte particulièrement aux espaces dans lesquels il est primordial de maximiser la surface d'exposition.

Der modische Aussteller für die trendigsten Locations. eignet sich perfekt für die Kreation von Verkaufswelten mit einem zeitgemäßen und internationalen Geschmack. Es zeichnet sich durch einen hohen technischen Gehalt und ein gelungenes Design aus und eignet sich ganz besonders für Bereiche, in denen der Ausstellraum maximal ausgeschöpft werden soll.

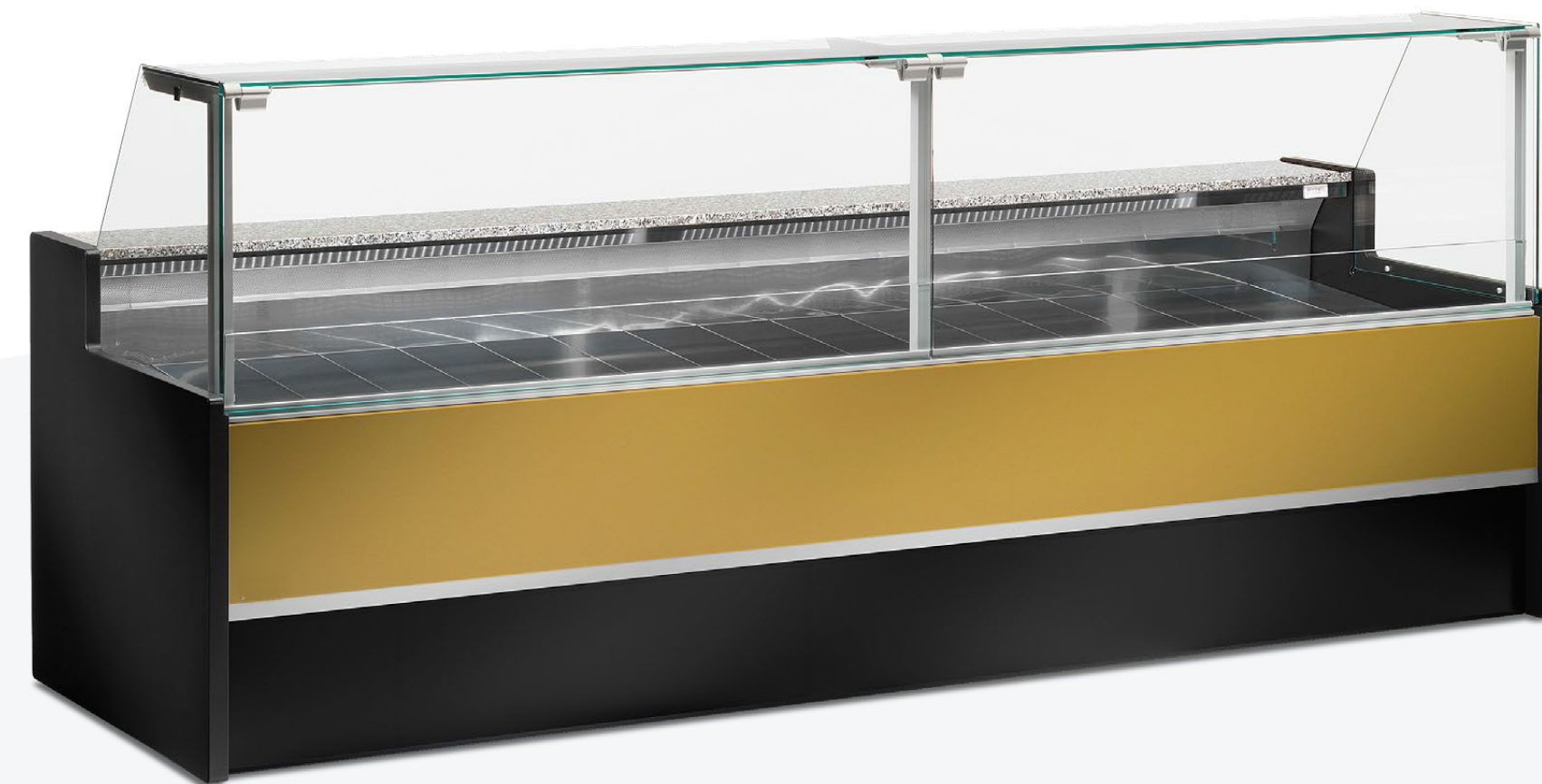

D153 Magic Gold  
Version  
D-2



# BANCO 2



1

Vetri apribili verso l'alto.

Lift up glass structure.

Structure avec verre s'ouvrant vers le haut.

Hebenverglasung Struktur.

2

Robusta struttura in alluminio.

Solid aluminium structure.

Structure robuste en aluminium.

Stabile Aluminium-Struktur.

3

Zona esposizione in acciaio Inox.

Display area in stainless steel.

Zone d'exposition en acier inox.

Auslagefläche aus Edelstahl.

4

Piano lavoro in granito (Rosa Beta).

Working plate in granit (Rosa Beta).

Plan de travail en granit (Rosa Beta).

Arbeitsplatte aus (Rosa Beta).

Tortora  
Version  
D-2 D152

I301  
Scotch Brite  
Version  
C-2

White Oak  
Version  
C-2 D136



Merce facile da posizionare con vetri frontali apribili.

The glass opens from the front to facilitate the display of goods.

Marchandise facile à exposer, grâce aux vitres frontales ouvrables.

Leicht zu positionierende Waren dank aufklappbarer Frontfenster.



Massima trasparenza.

Maximum transparency.

Transparence maximum.

Maximale Transparenz.

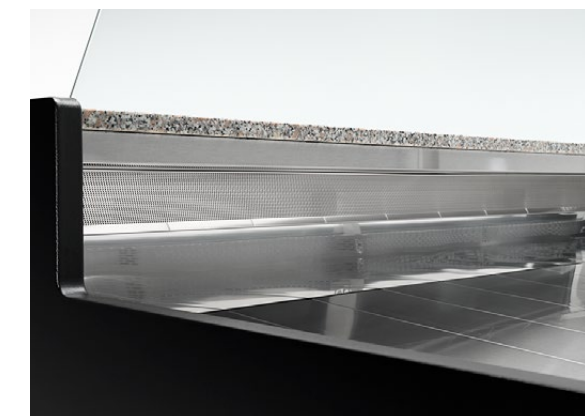

D2 Versione ventilata.

D2 ventilated version.

D2 Version ventilée.

D2 Belüftete Ausführung.



## BANCO 2 Versions

Gray **Black** Optional

Colori spalla  
End colours  
Couleurs des côtés  
Farben für Rückwände

C-1

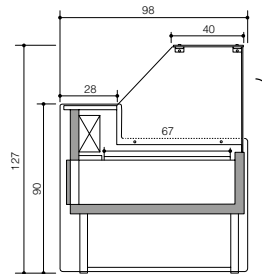

Vetri apribili a compasso -  
Statico con cella

Glass with hinged opening -  
Static with cool storage

Statique avec réserve -  
Vitres relevables

Fenster mit Kompassöffnung -  
Statisch mit Unterbaukuehlung

C-2

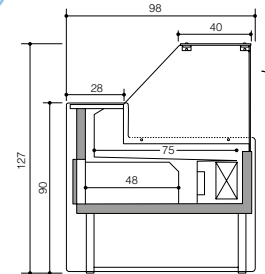

Vetri apribili a compasso -  
Ventilato con cella

Glass with hinged opening -  
Ventilated with cool storage

Ventiléé avec réserve -  
Vitres relevables

Fenster mit Kompassöffnung -  
Umluft mit Unterbaukuehlung

D-1

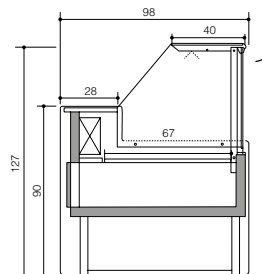

Vetri apribili verso l'alto -  
Statico con cella

Lift up glass structure -  
Static with cool storage

Structure avec verre s'ouvrant  
vers le haut - Statique avec réserve

Hebenverglasung Struktur -  
Statisch mit Unterbaukuehlung

D-2

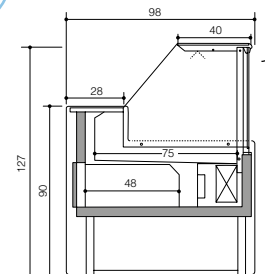

Vetri apribili verso l'alto -  
Ventilato con cella

Lift up glass structure -  
Ventilated with cool storage

Structure avec verre s'ouvrant  
vers le haut - Ventiléé avec réserve

Hebenverglasung Struktur -  
Umluft mit Unterbaukuehlung

Now, that's  
a trendy counter!





# BANCO 3



Width in cm.

81



Length in cm.

100 · 150  
200 · 250



Climate class

3 M2  
25°C / u.r. 60%

Un espositore dal design curato e attuale, da personalizzare per allinearlo allo stile del punto vendita.

è particolarmente indicato per pasticceria, pane, gastronomia, sandwich e in generale per negozi di piccole dimensioni: grazie alla sua larghezza di 81 cm può essere inserito in ambienti dallo spazio ridotto.

The search for contemporary design is what distinguishes this display, which can be customised according to the style of the store. It is specifically designed for pastry products, bread, gastronomy, sandwiches and for small stores. With a width of 81 cm it can fit tiny surfaces perfectly.

Un présentoir au design soigné et actuel, à personnaliser pour le coordonner au style du point de vente. est particulièrement indiqué pour les pâtisseries, les pains, les plats préparés, les sandwiches et, en général, pour les magasins de petites dimensions: grâce à sa largeur de 81 cm, il peut être inséré dans des espaces réduits.

Ein Aussteller mit einem präzisen und aktuellen Design, das an den Stil der Verkaufsstelle angepasst werden kann. eignet sich besonders für Süßwaren, Brot, Gastronomie, Sandwiches und im Allgemeinen für kleine Läden: dank seiner Breite von 81 cm kann es auch in kleineren Räumen aufgestellt werden.



D97 Black Version C-1

# BANCO 3



1

Vetro intermedio con illuminazione.  
Intermediate shelf with lighting.  
Vitre intermédiaire avec éclairage.  
Zwischenglaselage mit Beleuchtung.

2

Cappello in vetro.  
Upper glass.  
Chapeau en verre.  
Zahlplatte aus Glas.

3

Struttura con vetro fisso.  
Structure with fixed glass.  
Structure avec verre fixe.  
Struktur mit festen Glas.

4

Illuminazione LED.  
LED lighting.  
Éclairage LED  
LED-Beleuchtung

5

Zona esposizione in acciaio Inox.  
Display area in stainless steel.  
Zone d'exposition en acier inox.  
Auslagefläche aus Edelstahl.

White  
Version  
C-1

D110

## BANCO 3 Versions

Gray Black Optional

Colori spalla  
End colours  
Couleurs des côtés  
Farben für Rückwände



Esposizione e illuminazione ottimali con i ripiani intermedi in vetro.  
Optimal display and lighting thanks to its intermediate glass shelves.  
Exposition et éclairage optimaux avec des étagères intermédiaires en verre  
Optimale Präsentation und Beleuchtung mit den Zwischenregalen aus Glas



Piano di lavoro in granito (Rosa Beta) – Optional Nero assoluto.  
Granite worktop (Rosa Beta) – Optional Absolute Black.  
Plan de travail en granit (Rosa Beta) – En option, Noir absolu.  
Granit-Arbeitsplatte (Rosa Beta) – Optional tiefschwarz.



Esposizione ideale per i vostri piatti di gastronomia.  
Ideal for displaying gastronomic dishes.  
Exposition idéale pour vos plats préparés.  
Idealer Aussteller für Ihre kulinarischen Kreationen.

C-1

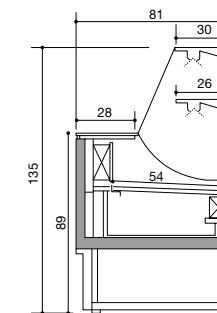

Statico con cella  
Static with cool storage  
Statique avec réserve  
Statisch mit Unterbaukuehlung

C-3

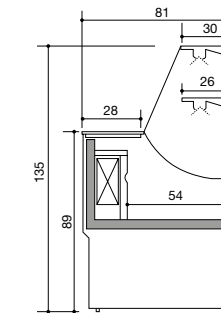

Statico senza cella  
Static without cool storage  
Statique sans réserve  
Statisch ohne Unterbaukuehlung

C-5

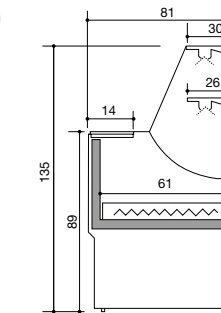

Versione calda (60°C)  
Hot Version (60°C)  
Version chaude (60°C)  
Warme Ausfuerung (60°)



# BANCO 4



Width in cm.

78



Length in cm.

100 · 120  
150



Climate class

3 M1  
25°C / u.r. 60%

Carisma e stile per una visibilità al top.

è l'espositore perfetto per la vendita di prodotti di qualità, in grado di offrire loro tutta la visibilità che meritano. È ideale per prodotti gastronomici, pasticceria e dolci, sandwich o piatti pronti.

Charisma and style for utmost visibility. is perfect for enhancing high quality products, offering them all the visibility they deserve. Ideal for gastronomic products, pastry creations and cakes, sandwiches or ready meals.

Charisme et style pour une meilleure visibilité. est le présentoir parfait pour la vente de produits de qualité, il est en mesure de leur offrir toute la visibilité qu'ils méritent. Il est parfait pour les produits préparés, les pâtisseries, les sandwiches ou les plats à emporter.

Charisma und Stil für höchste Sichtbarkeit. ist die perfekte Auslage für den Verkauf von Qualitätsprodukten, die gebührend in Szene gesetzt werden sollen. Es eignet sich hervorragend für gastronomische Produkte, Gebäck und Kuchen, Sandwiches oder Fertiggerichte.



D97 Black Version C-4

# BANCO 4

White Oak  
Version  
C-4

D136

D110

White  
Version  
C-4



1

Vetri Thermopane con serigrafia in nero.

Thermopane glasses with black serigraphy.

Vitres Thermopane sérigraphies noir.

Thermopane-Verglasungen mit schwarz Serigraphie.

2

Illuminazione verticale a LED.

LED lighting.

Éclairage LED

LED-Beleuchtung

3

Zona esposizione verniciata nero.

Display area black painted.

Zone d'exposition peint en noir.

Auslagefläche schwarz lackiert.

4

Ripiani in vetro refrigerati.

Refrigerated glass shelves.

Étagères en verre réfrigérées.

Gekühlte Glasregale.

5

Porte scorrevoli posteriori in Thermopane.

Rear sliding doors in Thermopane glass.

Portes coulissantes arrières en Thermopane.

Hintere Glasschiebetüren aus Thermopan





**BANCO 4**  
Versions



Gray **Black** Optional

Colori spalla  
End colours  
Couleurs des côtés  
Farben für Rückwände

C-4

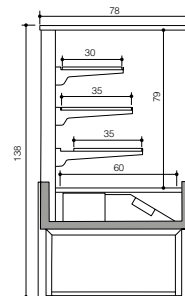

Ventilato senza cella  
Ventilated without cool storage  
Ventiléé sans réserve  
Umluft ohne Unterbaukuehlung

C-5

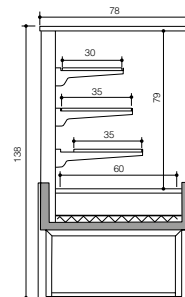

Versione calda (60°C)  
Hot Version (60°C)  
Version chaude (60°C)  
Warme Ausfuerung (60°)

C-6

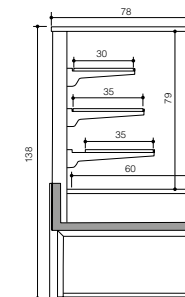

Non refrigerato  
Not refrigerated cabinet  
Sans réfrigération  
Nicht gekühlte Theke

You sure can  
see it all!





# BANCO 5



Width in cm.

91



Length in cm.

100 · 150  
200 · 250  
300



Climate class

3 M2  
25°C / u.r. 60%

Studiato per attirare l'attenzione.

è il modello di banco refrigerato ideale per attrarre i clienti: una vetrina perfetta per l'esposizione di prodotti di gastronomia, sandwich e piatti ready-to-eat. È disponibile con il vetro retto oppure con il vetro curvo.

Design to catch attention. A refrigerated counter to attract consumers' attention: the perfect counter to display gastronomic products, sandwiches and ready meals. Available with straight or curved glass.

Conçu pour attirer l'attention. est le modèle de comptoir réfrigéré idéal pour attirer les clients: une vitrine parfaite pour l'exposition de produits préparés, de sandwiches et de plats à emporter. Il est disponible avec une vitrine droite ou bien bombée.

Als Blickfang entwickelt, ist das ideale Kühlthekenmodell, um den Blick der Kunden auf sich zu ziehen: eine perfekte Vitrine für die Präsentation von Feinkostprodukten, Sandwiches und verzehrfertigen Gerichten. Es ist mit geradem oder gebogenem Glas erhältlich.

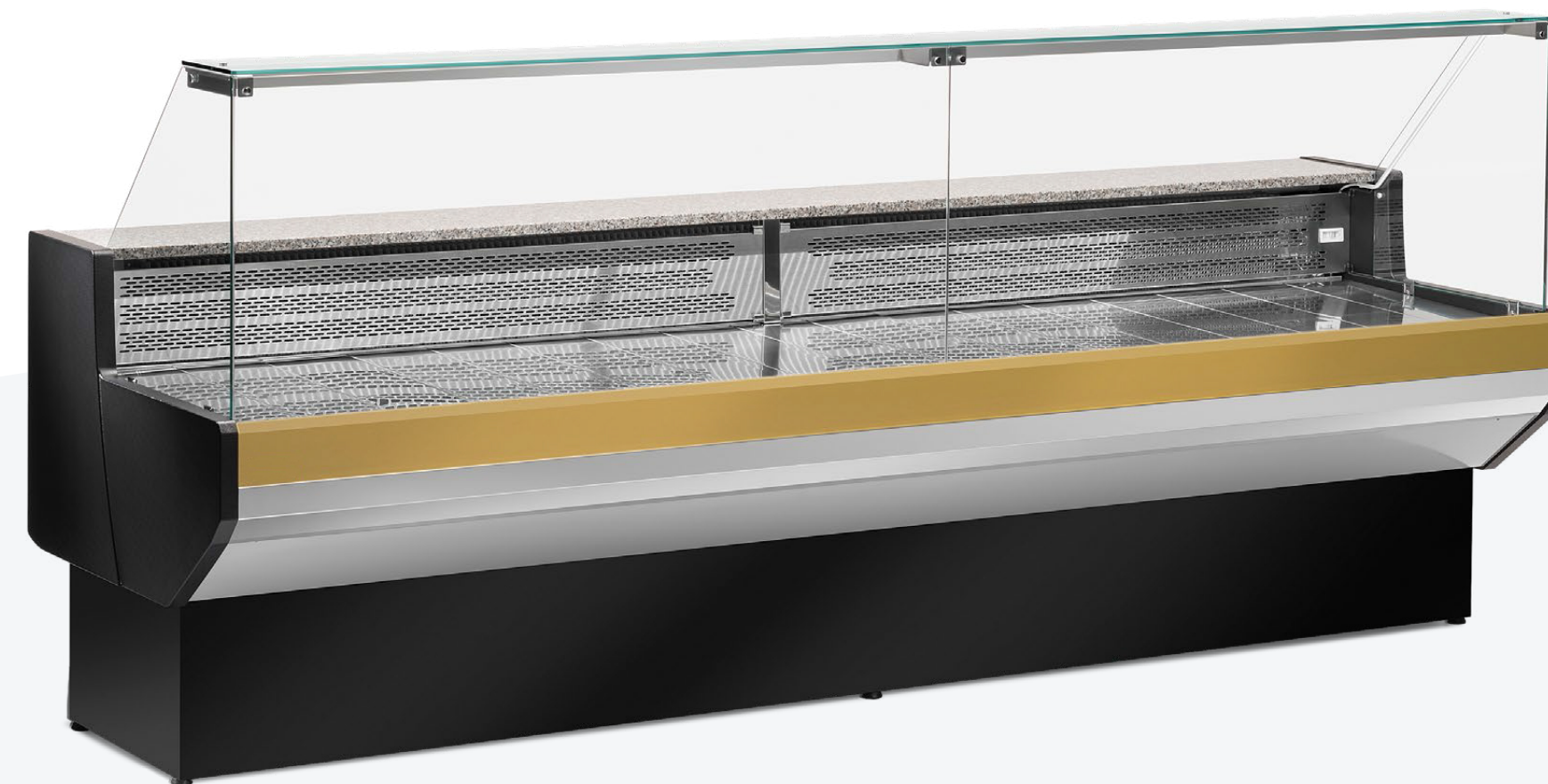

D153 Magic Gold  
Version  
C-1



# BANCO 5

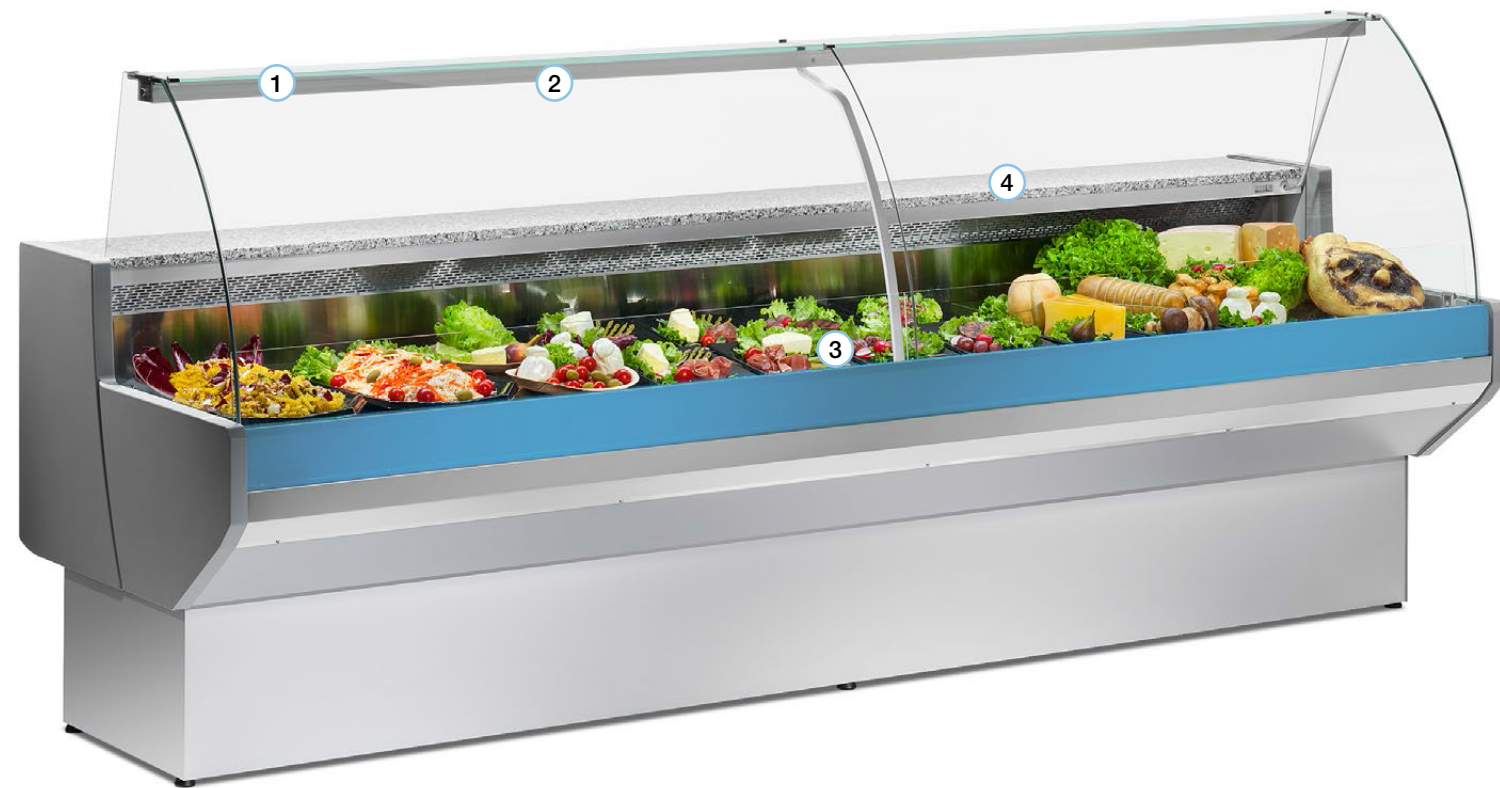

1

Struttura cappello in vetro curvo temperato.

Cap in curved tempered glass.

Structure plafond avec vitrine bombée en verre trempé.

Haubenstruktur aus gebogenem, gehärtetem Glas.

2

Illuminazione LED.

LED lighting.

Éclairage LED

LED-Beleuchtung

3

Zona esposizione in acciaio Inox.

Display area in stainless steel.

Zone d'exposition en acier inox.

Auslagefläche aus Edelstahl.

4

Piano lavoro in granito (Rosa Beta).

Working plate in granit (Rosa Beta).

Plan de travail en granit (Rosa Beta).

Arbeitsplatte aus (Rosa Beta).

Splendido  
Azzurro  
Y-2 D107

D97 Black  
Version Y-2



White Butter  
Version C-1 D151



D153 Magic Gold

Urban Wood D137

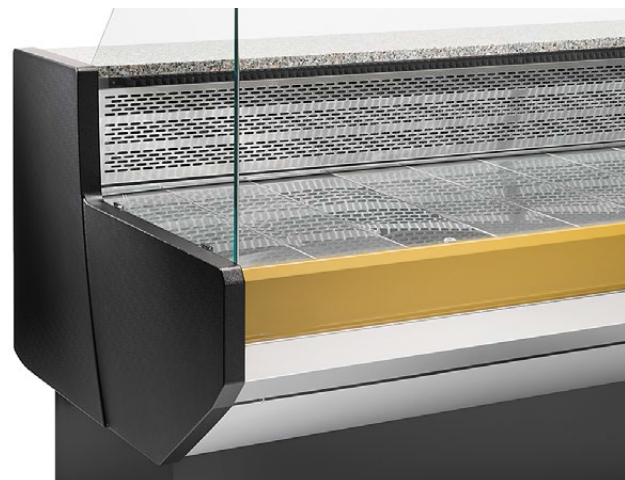



## BANCO 5 Versions

Gray Black Optional

Colori spalla  
End colours  
Couleurs des côtés  
Farben für Rückwände

C-1

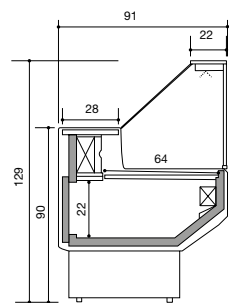

Statico con cella  
Static with cool storage  
Statique avec réserve  
Statisch mit Unterbaukuehlung

C-2

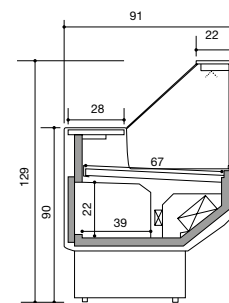

Ventilato con cella  
Ventilated with cool storage  
Ventiléé avec réserve  
Umluft mit Unterbaukuehlung

Y-1

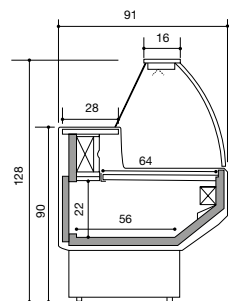

Statico con cella  
Static with cool storage  
Statique avec réserve  
Statisch mit Unterbaukuehlung

Y-2

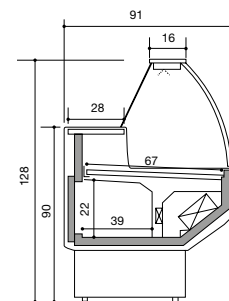

Ventilato con cella  
Ventilated with cool storage  
Ventiléé avec réserve  
Umluft mit Unterbaukuehlung



Eye-catching by design.



# BANCO 6



Width in cm.

79



Length in cm.

100 · 150  
200 · 250  
300



Climate class

3 M2  
25°C / u.r. 60%

Fai grande il tuo punto vendita in poco spazio.

è l'espositore perfetto per gli ambienti più ristretti, grazie ai suoi soli 79 cm di larghezza totale.

È studiato per massimizzare l'esposizione di salumi, formaggi e piatti pronti, l'ideale per ogni esigenza che richieda un banco refrigerato.

Make your store big in small space.

With a total width of only 79 cm, is perfect for small stores. Designed to enhance cold cuts, cheese and ready meals, can cater to any refrigerated counter needs.

Votre espace de vente s'agrandit sur peu d'espace.

est le présentoir parfait pour les espaces les plus restreints, grâce à sa largeur totale de 79 cm. Il est conçu pour maximiser l'exposition de charcuteries, de fromages et de plats préparés, l'idéal pour chaque exigence qui requiert un comptoir réfrigéré.

Machen Sie Ihr Geschäft auf kleinem Raum groß.

ist dank seiner Gesamtbreite von nur 79 cm die perfekte Auslage für kleinste Räume. Es wurde für die Auslage von Aufschnitt, Käse und Fertiggerichten entwickelt und ist ideal für jeden Einsatz, der eine Kühltheke erfordert.



D97 Black Version C-1

# BANCO 6

Green  
Version  
B-1 **D101**

**D136** White Oak  
Version  
B-1



1

Struttura e cappello in vetro.  
Top and upper glass structure.  
Structure et chapeau en verre.  
Glas und Zahlplatte Struktur.

2

Illuminazione LED.  
LED lighting.  
Éclairage LED  
LED-Beleuchtung

3

Zona esposizione in acciaio Inox.  
Display area in stainless steel.  
Zone d'exposition en acier inox.  
Auslagefläche aus Edelstahl.

4

Nr. 1 vetro intermedio.  
Nr. 1 intermediate shelf.  
Nr. 1 vitre intermédiaire.  
Nr. 1 Zwischenglaselage.

5

Piano lavoro in granito (Rosa Beta).  
Working plate in granit (Rosa Beta).  
Plan de travail en granit (Rosa Beta).  
Arbeitsplatte aus (Rosa Beta).





## BANCO 6 Versions

Gray

Black

Optional

Colori spalla  
End colours  
Couleurs des côtés  
Farben für Rückwände

B-1

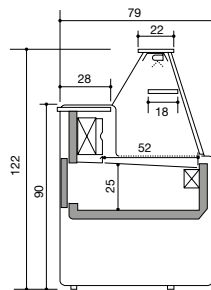

Statico con cella - Vetro dritto

Static with cool storage -  
Straight glass

Statique avec réserve - Vitre droite

Statisch mit Unterbaukuehlung -  
Gerades Glas

C-1

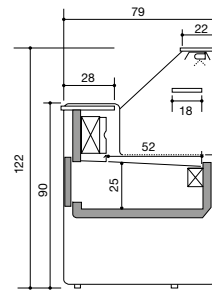

Statico con cella - Vetro retto

Static with cool storage -  
Upright glass

Statique avec réserve - Vitre verticale

Statisch mit Unterbaukuehlung -  
Rechteckiges Glas

Unlimited performance  
in a limited space.





# BANCO 7



La soluzione più efficiente per la vendita del pesce. Importante quanto delicata, l'esposizione del pesce necessita di un prodotto professionale ad hoc: è lo strumento perfetto per questa tipologia di alimento. I pratici gamboni in acciaio Inox, forniti di serie, garantiscono facile e veloce pulizia dell'ambiente.

The most efficient solution for the sale of fish. The delicate displaying and preservation of fish require a professional and specifically designed product: is the perfect counter for fish. The convenient stainless steel support legs, now provided as standard, enable fast and easy cleaning.

La solution la plus efficace pour la vente de poissons. L'exposition du poisson est importante et délicate et nécessite d'un produit professionnel ad hoc: est l'outil parfait pour cette typologie d'aliment. Les gros pieds pratiques en acier inox, fournis de série, garantissent un nettoyage rapide et facile de l'espace de vente.

Die effizienteste Lösung für den Verkauf von Fisch. Die wichtige und delikate Präsentation von Fisch benötigt ein professionelles Ad-hoc-Produkt: ist der perfekte Aussteller für diese Art von Lebensmitteln. Die praktischen Edelstahlbeine, die serienmäßig mitgeliefert werden, ermöglichen eine einfache und schnelle Reinigung der Räumlichkeiten.

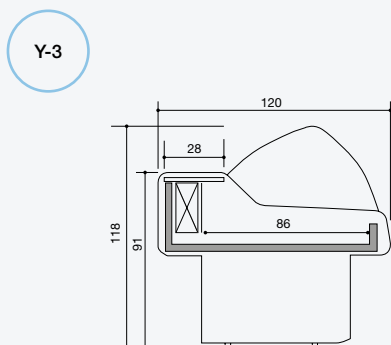
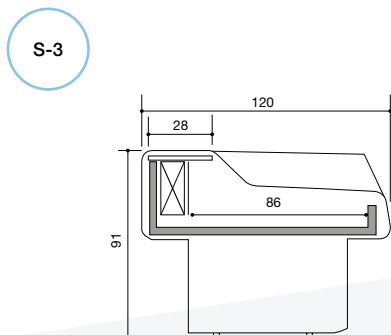

- 1 Ideale per esposizione e vendita del pesce.  
Ideal for display and sale of fish.  
Ideal pour l'exposition et la vente de poisson.  
Ideal für die Ausstellung und Verkauf von Fisch.
- 2 Zona esposizione in acciaio AISI 316.  
Display area in stainless steel AISI 316.  
Zone d'exposition en acier AISI 316.  
Auslagefläche aus Edelstahl AISI 316.
- 3 Piano lavoro in granito (Rosa Beta).  
Working plate in granit (Rosa Beta).  
Plan de travail en granit (Rosa Beta).  
Arbeitsplatte aus (Rosa Beta).
- 4 Vetro curvo.  
Curved glass.  
Vitre bombée.  
Gebogene Scheibe.

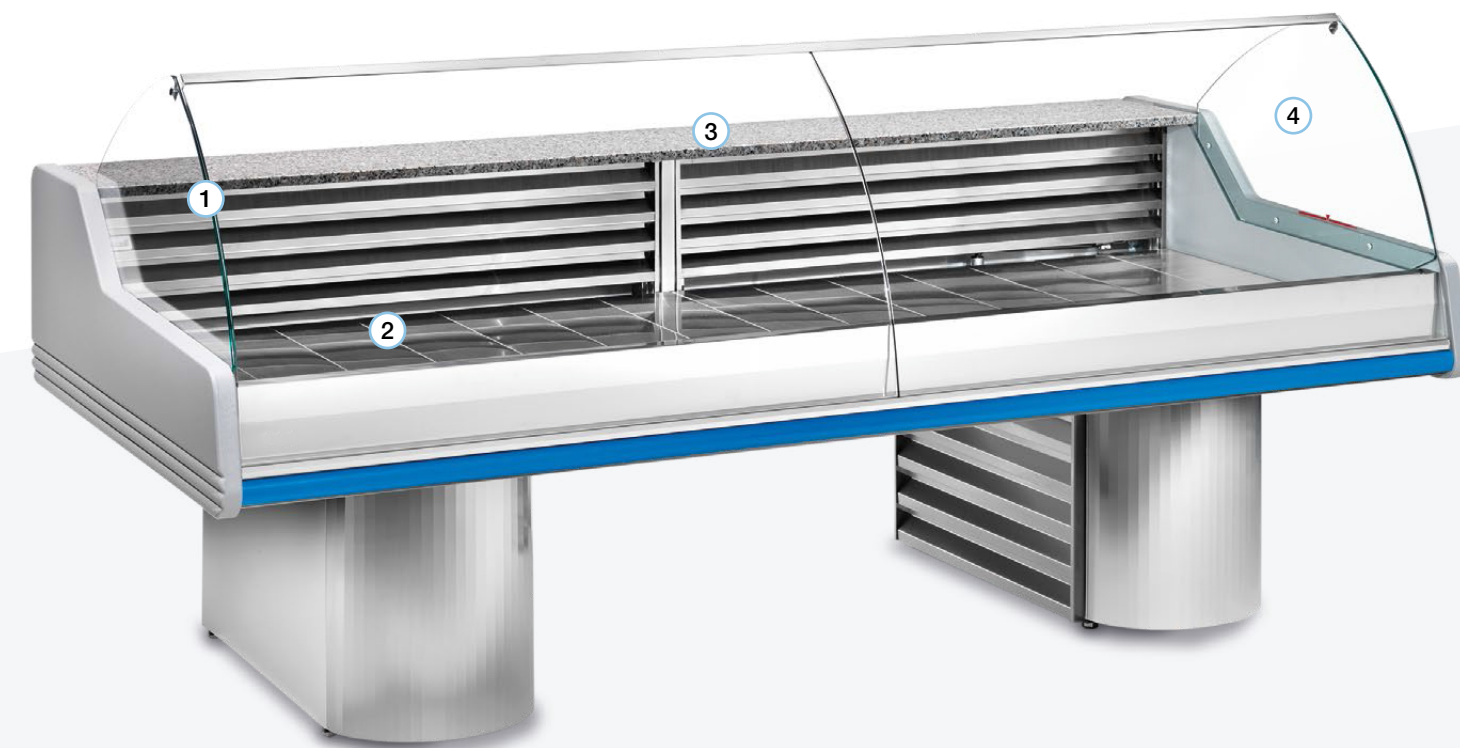

Gray  
Colori spalla  
End colours  
Couleurs des côtés  
Farben für Rückwände

- Width in cm. 120
- Length in cm. 150 · 200 · 250  
300 · 350
- Climate class 3 M1  
25°C / u.r. 60%

Version Y-3



# BANCO 8



Un modello senza tempo.

sinonimo di tradizione e robustezza,  
un modello che non segue le mode del momento.  
L'abbiamo progettato per la presentazione e la  
vendita di salumi, formaggi e altri prodotti di  
gastronomia.

A timeless model.  
rhymes with tradition and  
robustness without conforming with  
new trends. It has been designed  
for the display of cold cuts, cheese  
and gastronomic products in  
general.

Un modèle intemporel.  
est synonyme de tradition et de  
robustesse, un modèle qui ne suit  
pas les modes actuelles. Nous  
l'avons conçu pour la présentation  
et la vente de charcuteries, de  
fromages et d'autres produits  
préparés.

Ein zeitloses Modell.  
ist ein Synonym für Tradition und  
Stabilität, ein Modell, das  
sich nicht an den Moden des  
Augenblicks orientiert. Wir haben  
es für die Präsentation und den  
Verkauf von Wurstwaren, Käse und  
anderen gastronomischen  
Produkten konzipiert.

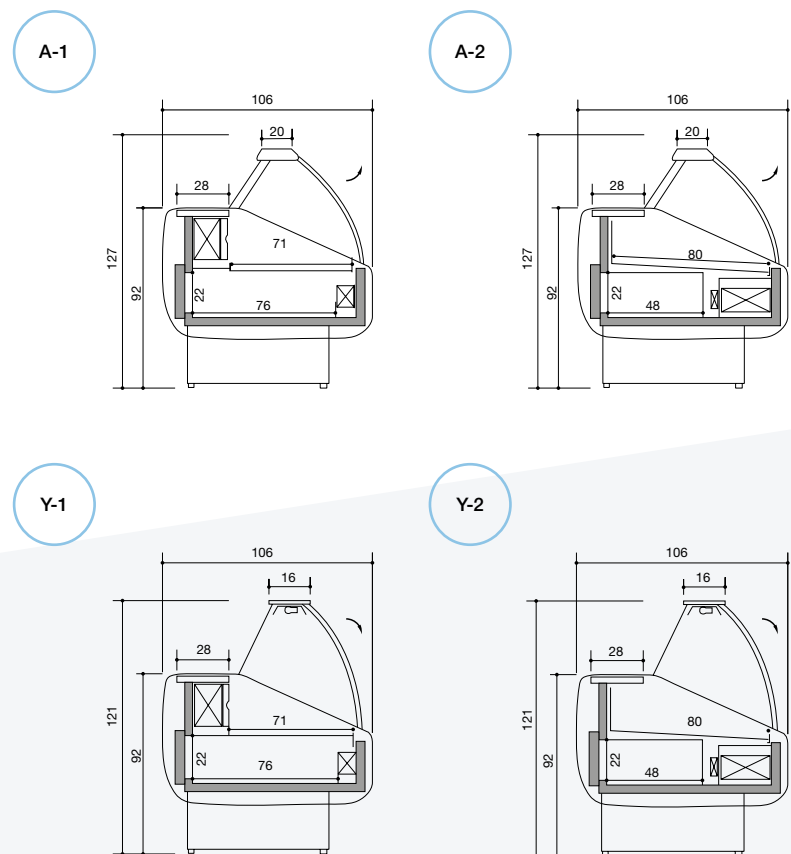

1

illuminazione LED.  
LED lighting.  
Éclairage LED.  
LED-Beleuchtung.

2

Zona esposizione in acciaio inox.  
Display area in stainless steel.  
Zone d'exposition en acier inox.  
Auslagefläche aus Edelstahl.

3

Piano lavoro in granito (Rosa Beta).  
Working plate in granit (Rosa Beta).  
Plan de travail en granit (Rosa Beta).  
Arbeitsplatte aus (Rosa Beta).

4

A1- A2: Struttura servoassistita.  
A1- A2: Servo-assisting upsetting  
glass.  
A1- A2: Overture servoassistite.  
A1- A2: Hebescheibenstruktur.

5

Y1-Y2: vetri apribili a compasso.  
Y1-Y2: bottom-hung glass.  
Y1-Y2: vitre rabattable.  
Y1-Y2: Gerade Kippscheiben.



Gray

Colori spalla  
End colours  
Couleurs des côtés  
Farben für Rückwände



Width in cm.  
106



Length in cm.  
150 · 200 · 250  
300 · 350 · 400



Climate class  
3 M2  
25°C / u.r. 60%

D96 Red  
Version  
Y-2



# BANCO 9



Width in cm.

98



Length in cm.

140 · 220  
290



Climate class

3 H2  
25°C / u.r. 60%

Eleganza per la pasticceria.

La vetrina perfetta per esporre la pasticceria refrigerata o secca con un'eleganza e una capacità espositiva che non hanno uguali. Progettato per massimizzare l'esposizione verticale, è un banco elegante che si armonizza con ogni ambiente di vendita.

Elegance at the pastry shop. This display is perfect to showcase both fresh and dry pastry creations with unparalleled elegance and display quality. Designed to enhance vertical display, is an elegant counter that attunes with any styles and store.

Élégance pour la pâtisserie. La vitrine parfaite pour exposer les pâtisseries réfrigérées ou sèches avec une élégance et une capacité d'exposition sans pareil. Conçue pour maximiser l'exposition verticale, est un présentoir élégant qui s'harmonise très bien avec n'importe quel espace de vente.

Eleganz für die Feinbäckerei. Die perfekte Vitrine für die Präsentation von gekühltem oder trockenem Gebäck mit einer Eleganz und Auslagekapazität, die ihresgleichen sucht. ist eine elegante Theke, die für eine maximale vertikale Präsentation ausgelegt ist und sich harmonisch in jede Verkaufsumgebung einfügt.



D136 White Oak  
Version  
C-3



# BANCO 9

White Butter  
Version  
Y-3

D151

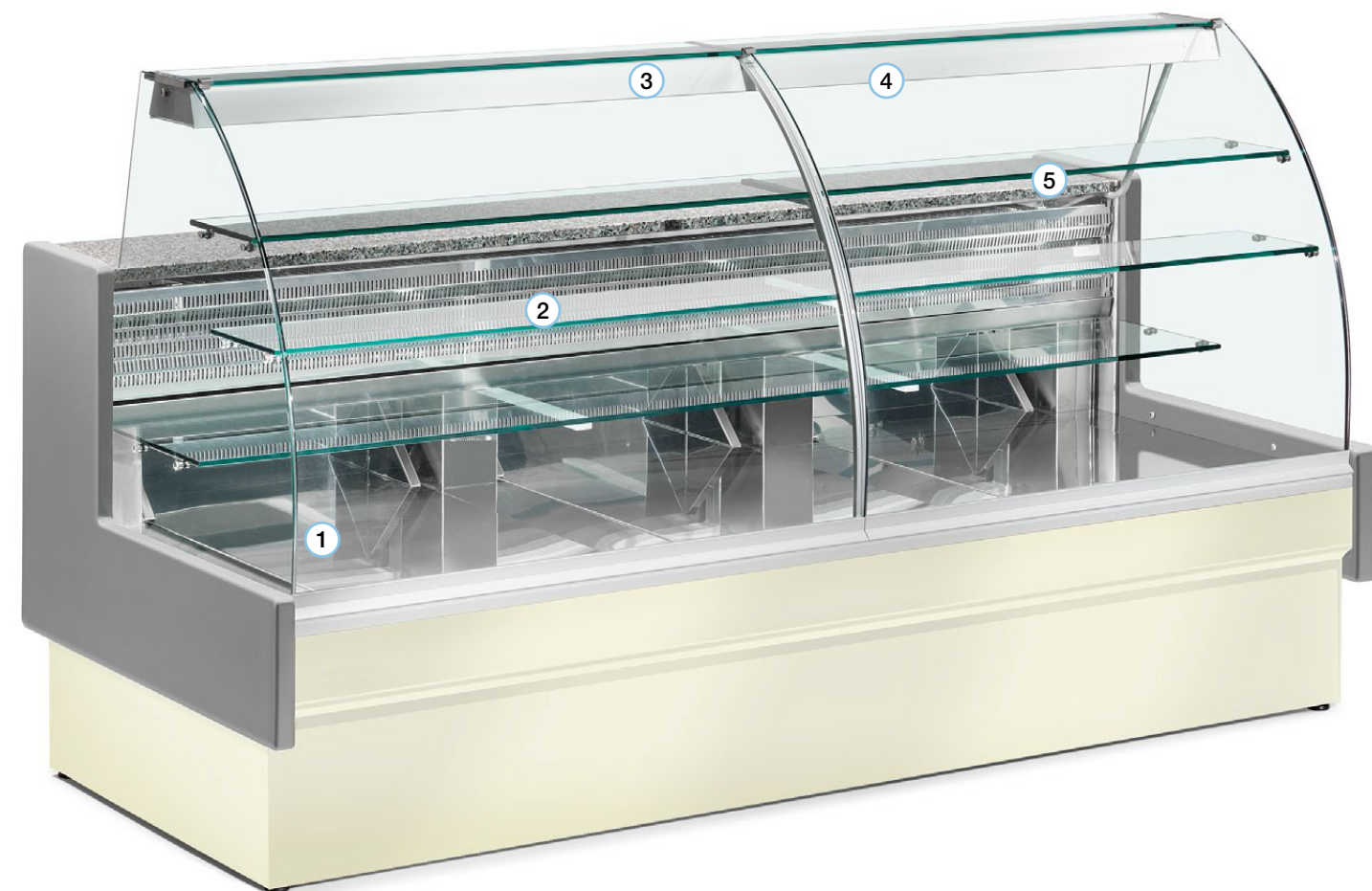

1

Zona esposizione in acciaio Inox.  
Display area in stainless steel.  
Zone d'exposition en acier inox.  
Auslagefläche aus Edelstahl.

2

Ripiani in vetro non refrigerati.  
Non-refrigerated glass shelves.  
Étagères en verre non réfrigérées.  
Nicht-gekühlte Glasregale.

3

Vetri apribili a compasso (C-3 e Y-3).  
Bottom-hung glass (C-3 e Y-3).  
Vitre rabattable (C-3 e Y-3).  
Gerade Kippscheiben (C-3 e Y-3).

4

Illuminazione LED.  
LED lighting.  
Éclairage LED.  
LED-Beleuchtung.

5

Piano lavoro in granito (Rosa Beta).  
Working plate in granit (Rosa Beta).  
Plan de travail en granit (Rosa Beta).  
Arbeitsplatte aus (Rosa Beta).

## BANCO 9 Versions

Gray Black Optional

Colori spalla.  
La parte inferiore della spalla è personalizzabile con il colore del frontale scelto.

End colours.  
The lower part of the sidewall can be customised with the colour of the chosen front.

Couleurs des côtés.  
La partie inférieure du côté est personnalisable avec la couleur de la face avant choisie.

Farben für Rückwände.  
Der untere Teil der Rückwand kann farblich an die gewählte Front angepasst werden.

C-3

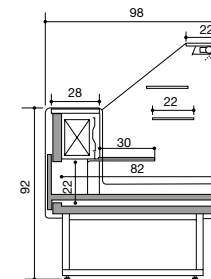

Y-3

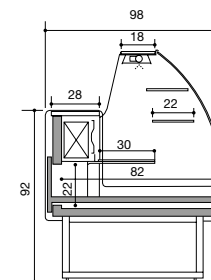

Statico con cassettoni scorrevole  
Static with slidign drawer  
Statique avec tiroir coulissant  
Statisch mit schublade



Statico con cassettoni scorrevole  
Static with slidign drawer  
Statique avec tiroir coulissant  
Statisch mit schublade





# VETRINA 1



1

Cappello in vetro.  
Upper glass.  
Chapeau en verre.  
Zahlplatte aus Glas.

2

Illuminazione LED.  
LED lighting.  
Éclairage LED.  
LED-Beleuchtung.

3

Zona esposizione in acciaio Inox.  
Display area in stainless steel.  
Zone d'exposition en acier inox.  
Auslagefläche aus Edelstahl.

Pronto a soddisfare tutte le esigenze.

espositore refrigerato versatile ed economico adatto a qualsiasi esigenza. Ideale nel mondo della ristorazione per esibire piatti pronti, sandwich, prodotti gastronomici o pesce fresco.

Ready to cater to your needs. Is a versatile and low-cost refrigerated counter that can suit any needs. Perfect for catering display of ready dishes, sandwiches, gastronomic products or fresh fish.

Prêt pour satisfaire toutes les exigences. est le présentoir réfrigéré universel et économique adapté à toutes les exigences. Il est idéal dans le monde de la restauration pour présenter les plats préparés, les sandwiches, les produits gastronomiques ou les poissons frais.

Bereit, allen Anforderungen gerecht zu werden. ist der vielseitige und preisgünstige Kühlaussteller, der für jeden Bedarf geeignet ist. Ideal in der Welt der Gastronomie, um Fertiggerichte, Sandwiches, kulinarische Produkte oder frischen Fisch auszustellen.

B-7

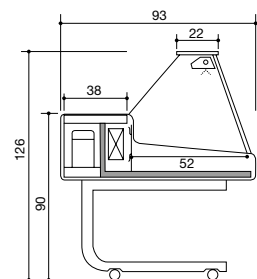

S-7

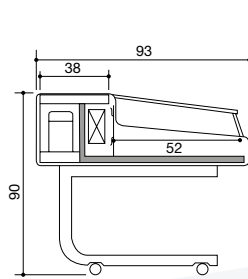

Y-7

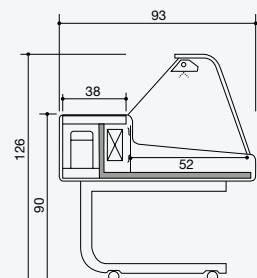

Y-7 Fish

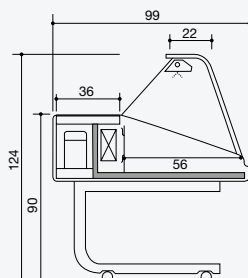

Gray

Colori spalla  
End colours  
Couleurs des côtés  
Farben für Rückwände



Width in cm.  
93/99



Length in cm.  
100 - 150



Climate class  
Y7: 3 M2  
Y7 Fish: 3 M1  
25°C / u.r. 60%

Version  
Y-7



# MURALE 1



Massima visibilità per i nuovi concept store.

Il banco murale refrigerato studiato per garantire massimo risalto al prodotto esposto nei nuovi concept store. Ideale per prodotti quali salumi, formaggi, frutta e verdura, take-away e bibite.

Utmost visibility for new concept stores. is a refrigerated wall display perfect for ensuring the utmost enhancement of products in new concept stores. Ideal for products such as cold cuts, cheese, fruits and vegetables, take away dishes and drinks.

Grande visibilité pour les nouveaux concepts stores. Le présentoir mural réfrigéré a été conçu pour présenter de manière plus efficace les produits exposés dans les nouveaux concepts stores. Il est idéal pour les produits comme les charcuteries, les fromages, les fruits et les légumes, les plats à emporter et les boissons.

Maximale Sichtbarkeit für die neuen Concept Stores. Die Wand-Kühltheke ist so konzipiert, dass sie eine maximale Sichtbarkeit der in den neuen Concept Stores ausgestellten Produkte garantiert. Ideal für Aufschnitt, Käse, Obst und Gemüse, Take-away und Erfrischungsgetränke.



Width in cm.

75



Length in cm.

70 · 100 · 120  
150 · 180 · 200



Climate class

B200: 3-M2  
B200 VIEW: 3-M1



Shelf Depth in cm.

34



Load capacity in lt.

70 = 284 lt.  
100 = 422 lt.  
120 = 514 lt.  
150 = 651 lt.  
180 = 789 lt.  
200 = 881 lt.

D97 Black Version B-200 VIEW



# MURALE 1



D138 Larchwood  
Version  
B-200

1

Zona esposizione in acciaio Inox.  
Display area in stainless steel.  
Zone d'exposition en acier inox.  
Auslagefläche aus Edelstahl.

2

Illuminazione LED.  
LED lighting.  
Éclairage LED  
LED-Beleuchtung

3

Ripiani inclinabili e regolabili  
in altezza.  
Inclinable and height adjustable  
shelves.  
Étagères inclinables et réglables  
en hauteur.  
Möglichkeit von schräger und  
höhenverstellbare Fachböden.

4

Spalla panoramica (Optional).  
Panoramic sidewalls (Optional).  
Côté Panoramique (En option).  
Panorama-Rückwand (Optional).



D102 Orange  
Version  
B-200





## MURALE 1 Versions

Gray

Black

Optional

Colori spalla  
End colours  
Couleurs des côtés  
Farben für Rückwände

B-200

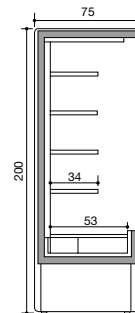

4 ripiani  
4 shelves  
4 étagères  
4 Fachböden

B-200  
View

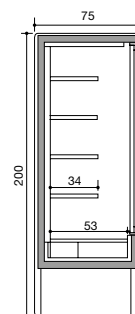

4 ripiani - porte scorrevoli  
4 shelves - sliding doors  
4 étagères - porte coulissantes  
4 Fachböden - Schiebetüren

F-200

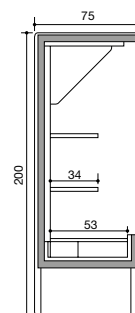

2 ripiani con specchio  
2 shelves with mirror  
2 étagères avec miroir  
2 Fachböden mit spiegel



A whole new concept  
for concept stores.



## MURALE 2



Semplicità, design, convenienza.

Design accattivante, versatilità e ottimo rapporto qualità-prezzo sono gli ingredienti per questo murale “Freshness to go”.

Dal concetto costruttivo semplice

- con ripiani in appoggio e blocchi ancorati alle spalle
- è adatto per l’esposizione di salumi, formaggi, frutta e verdura, take-away e bibite.

Simplicity, design and value for money. Attractive design, versatility and excellent value for money are the ingredients for this “Freshness to go” refrigerated wall display. Its clean design - with supporting shelves and blocks fixed to the sides - is ideal for displaying cold cuts, cheese, fruits and vegetables, take away dishes and drinks.

Simple, design, avantageux. Le design attrayant, l'universalité et l'excellent rapport qualité-prix sont les qualités de présentoir mural “Freshness to go”. Grâce à son concept de construction très simple – avec des étagères en appui sur les joues ancrées aux côtés – il convient parfaitement pour l'exposition des charcuteries, des fromages, des fruits et des légumes, des plats prêts à emporter et des boissons.

Schlichtheit, Design, Zweckmäßigkeit. Ansprechendes Design, Vielseitigkeit und ein ausgezeichnetes Preis-Leistungs-Verhältnis sind die Eigenschaften von das Wandkühlregal „Freshness to go”. Mit seinem einfachen Aufbau und den an den Rückwänden verankerten Blöcke - eignet es sich für die Auslage von Aufschnitt, Käse, Obst und Gemüse, Take-away und Erfrischungsgetränken.



Width in cm.

71



Length in cm.

70 · 100 · 120  
150 · 180



Climate class

A-200: 3 M2  
A-200 VIEW: 3 M1



Shelf Depth in cm.

34



Load capacity in lt.

70 = 284 lt.  
100 = 422 lt.  
120 = 514 lt.  
150 = 651 lt.  
180 = 789 lt.

D107 Splendido  
Azzurro  
A-200



# MURALE 2



D137 Urban Wood  
Version  
A-200 VIEW

1

Ripiani in appoggio su blocchi ancorati alle spalle.

Supporting shelf-blocks fixed to the sides.

Étagères en appui sur les joues ancrées aux côtés.

Regale, die auf an den Rückwänden verankerten Blöcken aufliegen.

2

Illuminazione LED.

LED lighting.

Éclairage LED

LED-Beleuchtung

3

Zona esposizione in acciaio Inox.

Display area in stainless steel.

Zone d'exposition en acier inox.

Auslagefläche aus Edelstahl.

4

Porte scorrevoli in vetro Thermopane.

Sliding doors in Thermopane glass.

Portes coulissantes en verre Thermopane.

Thermopanglas-Schiebetüren.

D136 White Oak  
Version  
A-200 with Night Curtain

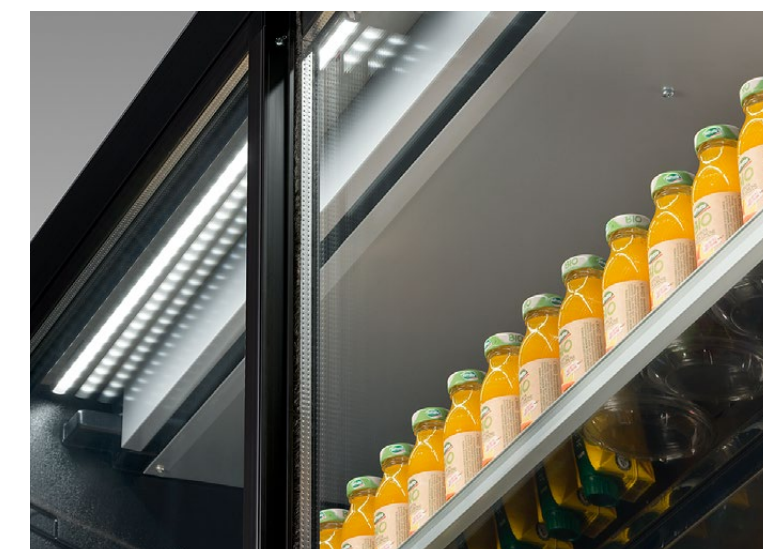



## MURALE 2 Versions

Gray **Black** Optional

Colori spalla  
End colours  
Couleurs des côtés  
Farben für Rückwände



A-200

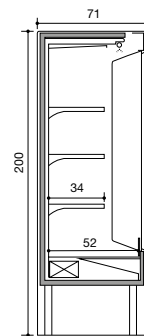

3 ripiani  
3 shelves  
3 étagères  
3 Fachböden

A-200  
View

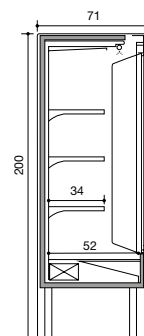

3 ripiani - porte scorrevoli  
3 shelves - sliding doors  
3 étagères - porte coulissantes  
3 Fachböden - Schiebetüren

Black  
Version  
A-200 **D97**



# Freshness to go.



# MURALE 3



La migliore soluzione espositiva per sfruttare gli spazi.

nuovo murale refrigerato a profondità ridotta – solo 57 cm – per i piccoli punti vendita. È disponibile sia con ripiani inclinabili e regolabili in altezza, sia con ripiani in appoggio su blocchi ancorati alle spalle.

Sviluppato per l'esposizione di prodotti gastronomici come salumi, formaggi e bibite.

The best display solution to make the most of any space. is the new refrigerated wall display, reduced in thickness - only 57 cm - for small stores. It is available both with tilting and height-adjustable shelves and with supporting shelf-blocks fixed to the sides. Designed for the display of gastronomic products, such as cold cuts, cheese and drinks.

La meilleure solution d'exposition pour exploiter les espaces. Est le nouveau présentoir mural réfrigéré avec une profondeur réduite – seulement 57 cm – pour les petits points de vente. Il est disponible aussi bien avec des étagères inclinables et réglables en hauteur qu'avec des étagères en appui sur des joues ancrées aux côtés. Il a été développé pour exposer des produits gastronomiques comme les charcuteries, les fromages et les boissons.

Die Präsentationslösung zur besten Raumausnutzung. ist das neue Wandkühlregal mit reduzierter Tiefe - nur 57 cm - für kleine Verkaufsstellen. Es ist sowohl mit kippbaren und höhenverstellbaren Regalen als auch mit Regalen erhältlich, die auf an den Rückwänden verankerten Blöcken ruhen. Entwickelt für die Ausstellung von gastronomischen Produkten wie Aufschnitt, Käse und Erfrischungsgetränken.



D153 Magic Gold Version B-200 VIEW



Width in cm.

57



Length in cm.

70 · 100  
120 · 150  
180 · 200



Climate class

A-200, B-200: 3 M2  
A e B-200 VIEW: 3 M1



Shelf Depth in cm.

29



Load capacity in lt.

70 = 242 lt.  
100 = 360 lt.  
120 = 438 lt.  
150 = 555 lt.  
180 = 673 lt.  
200 = 751 lt.



# MURALE 3

Scotch Brite  
Version  
B-200 VIEW I301

D102 Orange  
Version  
B-200 VIEW

White Oak  
Version  
A-200 D136



1

Zona esposizione in acciaio Inox.  
Display area in stainless steel.  
Zone d'exposition en acier inox.  
Auslagefläche aus Edelstahl.

2

Illuminazione LED.  
LED lighting.  
Éclairage LED  
LED-Beleuchtung

3

B200 – B200 VIEW: Ripiani inclinabili e regolabili in altezza.  
B200 – B200 VIEW: Tilting and height-adjustable shelves.  
B200 – B200 VIEW: Étagères inclinables et réglables en hauteur.  
B200 – B200 VIEW: Kippbare höhenverstellbare Regale.

4

A200 – A200 VIEW: Ripiani in appoggio su blocchi ancorati alle spalle.  
A200 – A200 VIEW: Shelves resting on blocks anchored to the sidewalls.  
A200 – A200 VIEW: Étagères en appui sur des joues ancrées aux côtés.  
A200 – A200 VIEW: Regale, die auf an den Rückwänden verankerten Blöcken ruhen.

5

Spalla panoramica (Optional).  
Panoramic sidewalls (Optional).  
Côté Panoramique (En option).  
Panorama-Rückwand (Optional).





## MURALE 3 Versions

Gray **Black** Optional

Colori spalla  
End colours  
Couleurs des côtés  
Farben für Rückwände

A-200

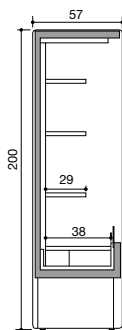

3 ripiani  
3 shelves  
3 étagères  
3 Fachböden

A-200  
View

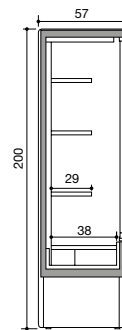

3 ripiani - porte scorrevoli  
3 shelves - sliding doors  
3 étagères - porte coulissantes  
3 Fachböden - Schiebetüren

B-200

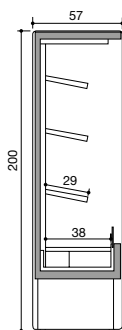

3 ripiani  
3 shelves  
3 étagères  
3 Fachböden

B-200  
View

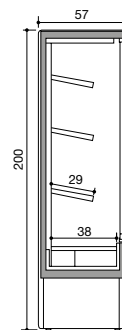

3 ripiani - porte scorrevoli  
3 shelves - sliding doors  
3 étagères - porte coulissantes  
3 Fachböden - Schiebetüren



So slim it can fit anywhere.



# MURALE 4



Width in cm.  
75



Length in cm.  
70 · 100  
120 · 150  
180 · 200



Climate class  
B200: 3 M2  
B200 VIEW: 3 M1  
25°C / u.r. 60%



Shelf Depth in cm.  
34



Load capacity in lt.  
70 = 257 lt.  
100 = 381 lt.  
120 = 464 lt.  
150 = 589 lt.  
180 = 713 lt.  
200 = 796 lt.

## Resistenza garantita.

Vi sono esigenze espositive che necessitano di una maggiore resistenza dei materiali costruttivi che potrebbero, direttamente o indirettamente, entrare in contatto con il prodotto alimentare. Per soddisfarle Con tutte le finiture interne della vasca e dei suoi componenti in acciaio Inox.

Guaranteed robustness. When display materials may directly or indirectly come in contact with food, more resistant construction materials are demanded. The answer is the internal finishes of its tank are in stainless steel, as are its components.

Résistance garantie. Il existe des exigences d'exposition qui nécessitent d'une plus grande résistance des matériaux de construction qui pourraient directement ou indirectement, rentrer en contact avec le produit alimentaire. Pour les satisfaire, avec toutes les finitions internes du bac et de ses composants en acier inox.

Garantierte Widerstandsfähigkeit. Es gibt Ausstellungssituationen, die eine höhere Beständigkeit von Materialien erfordern, die direkt oder indirekt mit Lebensmitteln in Kontakt kommen können. Um ihnen gerecht zu werden gibt. Hier ist die gesamte Verkleidung der Innenschale und ihrer Komponenten aus rostfreiem Stahl.

B-200

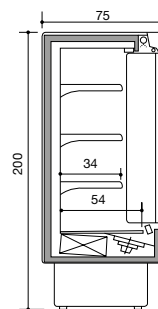

B-200 View

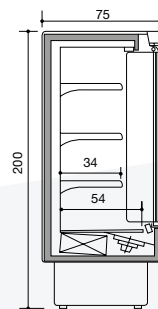

I301 Scotch Brite

Colori spalla  
End colours  
Couleurs des côtés  
Farben für Rückwände

Scotch Brite  
Version  
B-200 VIEW



1

Zona esposizione, vasca interna e finiture esterne in acciaio inox.

Stainless steel display area, internal tank and external finishes.

Zone d'exposition, bac interne et finitions externes en acier Inox.

Ausstellungsbereich, Innenschale und Außenverkleidung aus Edelstahl.

2

Illuminazione LED.

LED lighting.

Éclairage LED.

LED-Beleuchtung.

3

Ripiani inclinabili e regolabili in altezza.

Inclinable and height adjustable shelves.

Étagères inclinables et réglables en hauteur.

Möglichkeit von schräger und höhenverstellbare Fachböden.



# MURALE 5



Width in cm.  
75



Length in cm.  
100 · 120  
150 · 180  
200



Climate class  
3 M2  
25°C / u.r. 60%



Shelf Depth in cm.  
34



Load capacity in lt.  
100= 381 lt.  
120=464 lt.  
150=589 lt.  
180=713 lt.  
200=796 lt.

Piccole superfici, grandi performance.

murale refrigerato dalle dimensioni contenute, perfetto da posizionare all'interno di locali con superfici ridotte. Adatto all'esposizione di salumi, formaggi, frutta e verdura, take-away e bibite.

Small surfaces, big performance. Is a wall refrigerated display that fit into small retail spaces. Ideal for displaying cold cuts, cheese, fruits and vegetables, take away dishes and drinks.

Petites surfaces, grandes performances. est le présentoir mural réfrigéré aux dimensions limitées, il est parfait pour être positionné dans des pièces ayant des surfaces réduites. Il convient parfaitement pour exposer des charcuteries, des fromages, des fruits et des légumes, des plats prêts à emporter et des boissons.

Kleine Flächen, große Leistung. ist das gekühlte Wandregal mit kleinen Abmessungen, das sich perfekt in Räumen mit kleinen Flächen einsetzen lässt. Geeignet für die Auslage von Aufschnitt, Käse, Obst und Gemüse, Take-away und Erfrischungsgetränken.

B-180

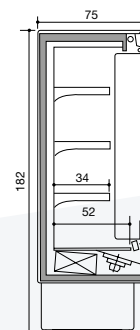

Gray

Colori spalla  
End colours  
Couleurs des côtés  
Farben für Rückwände

D103 Blue Version  
B-180



1

Ripiani inclinabili e regolabili in altezza.

Inclinable and height adjustable shelves.

Étagères inclinables et réglables en hauteur.

Möglichkeit von schräger und höhenverstellbare Fachböden.

2

Illuminazione LED.

LED lighting.

Éclairage LED.

LED-Beleuchtung.

3

Zona esposizione in acciaio Inox.

Display area in stainless steel.

Zone d'exposition en acier inox.

Auslagefläche aus Edelstahl.



# MURALE 6



Un murale grande per grandi performance.

nuovo murale refrigerato che si distingue per le alte prestazioni e l'elevata capacità di carico.

È particolarmente adatto ai locali che vantano superfici di dimensioni medie o grandi.

A spacious wall display to deliver great performance. Is the new refrigerated display standing out for its high performance and load capacity. Particularly suitable for medium-large surfaces.

Un grand présentoir mural pour de grandes performances. est le nouveau présentoir mural réfrigéré caractérisé par ses performances élevées et sa grande capacité de charge. Il est particulièrement adapté à des surfaces de moyennes ou de grandes dimensions.

Ein großes Wandkühlregal für große Leistung. ist das neue gekühlte Wandregal, das sich durch seine hohe Leistung und hohe Belastbarkeit auszeichnet. Es eignet sich besonders für Räume mit mittleren oder großen Flächen.



D113 Yellow Version B-200



Width in cm.

82



Length in cm.

93,7 · 125  
187,5 · 250



Climate class

B-200 e F-200: 3 M2  
B-200 VIEW: 3 M1



Shelf Depth in cm.

51



Load capacity in lt.

93,7 = 692 lt.  
125 = 924 lt.  
187,5 = 1386 lt.  
250 = 1848 lt.



# MURALE 6



D153 Magic Gold  
Version  
B-200 VIEW

1

Ripiani inclinabili e regolabili  
in altezza.

Inclinable and height adjustable  
shelves.

Étagères inclinables et réglables  
en hauteur.

Möglichkeit von schräger und  
höhenverstellbare Fachböden.

2

Illuminazione LED.

LED lighting.

Éclairage LED

LED-Beleuchtung

3

Zona esposizione in acciaio Inox.

Display area in stainless steel.

Zone d'exposition en acier inox.

Auslagefläche aus Edelstahl.

4

Canalizzabile.

Multiplexable.

Canalisable.

Kanalierbar.

D151 White Butter  
Version  
B-200 VIEW



White Oak  
Version  
B-200 D136

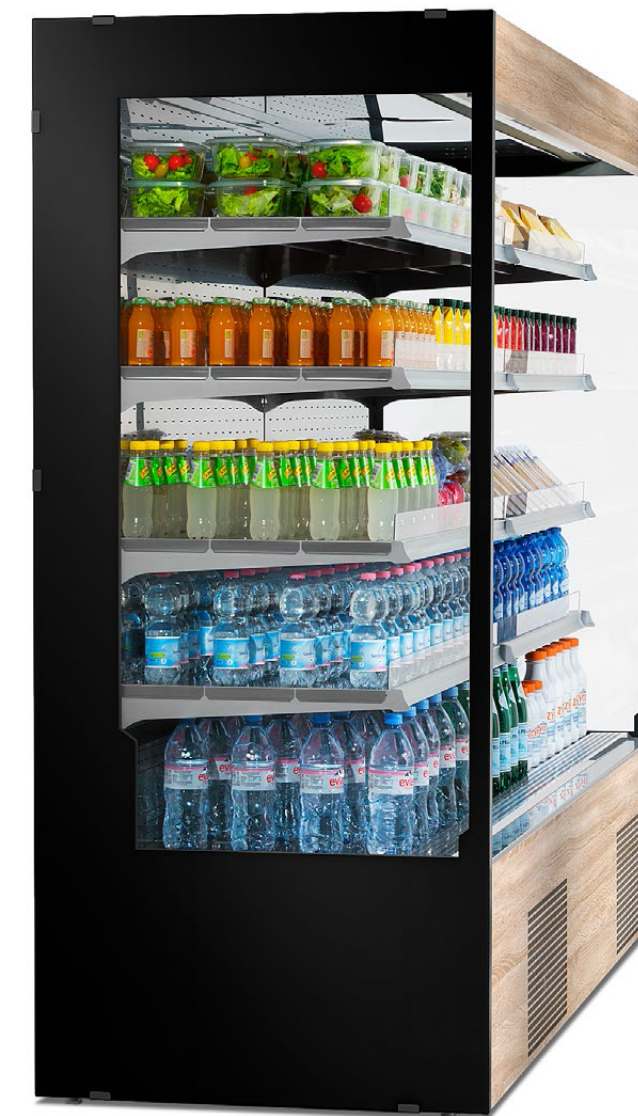



## MURALE 6 Versions

Gray **Black** Optional

Colori spalla  
End colours  
Couleurs des côtés  
Farben für Rückwände

**Black**

Colori spalle panoramiche  
Panoramic sidewalls  
Couleurs des côtés panoramiques  
Farben für Panorama-Rückwände

B-200

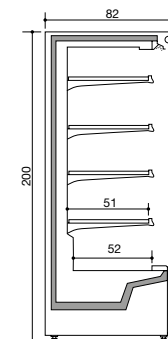

4 ripiani  
4 shelves  
4 étagères  
4 Fachböden

B-200  
View

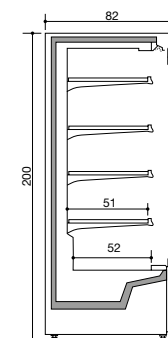

4 ripiani - porte scorrevoli  
4 shelves - sliding doors  
4 étagères - porte coulissantes  
4 Fachböden - Schiebetüren

F-200

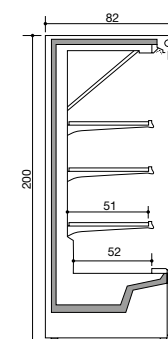

3 ripiani con specchio  
3 shelves with mirror  
3 étagères avec miroir  
3 Fachböden mit spiegel



Need space? Here you are!



# SELF SERVICE 1



Width in cm.

91



Length in cm.

125 · 187,5  
250 · 312,5



Climate class

3 M2  
25°C / u.r. 60%



Shelf Depth in cm.

25/35



Load capacity in lt.

125 = 263 lt.  
187,5 = 394 lt.  
250 = 455 lt.  
312,5 = 677 lt.

Estrema praticità per la vendita promozionale.

progettato per l'esposizione e la vendita di prodotti take-away, ma è perfetto anche per ogni layout con aree promozionali di forte impatto.

È inoltre ideale per preservare tutte le proprietà e gli aromi del sushi e permette ai clienti di servirsi in totale libertà.

Utmost convenience for promotional sale. Has been designed to showcase and sell take away products, however, it fits perfectly in any retail surface with high-impact promotional areas. Ideal to preserve all the characteristics and flavours of sushi while enabling customers to help themselves.

Extrêmement pratique pour la vente promotionnelle. A été conçu pour l'exposition et la vente de produits à emporter, mais il est également parfait pour tous les aménagements de grand impact dans des espaces promotionnels. Il est aussi idéal pour préserver toutes les propriétés et tous les arômes du sushi et permet aux clients de se servir en toute liberté.

Äußerst praktisch für Werbeerkäufe. Ist für die Ausstellung und den Verkauf von Produkten zum Mitnehmen konzipiert. Er eignet sich aber auch perfekt für alle anderen Layouts mit hochwirksamen Werbeflächen. Es ist auch ideal, um alle Eigenschaften und Aromen von Sushi zu erhalten und ermöglicht es den Kunden, sich vollkommen frei zu bedienen.



D97 Black Version B-130

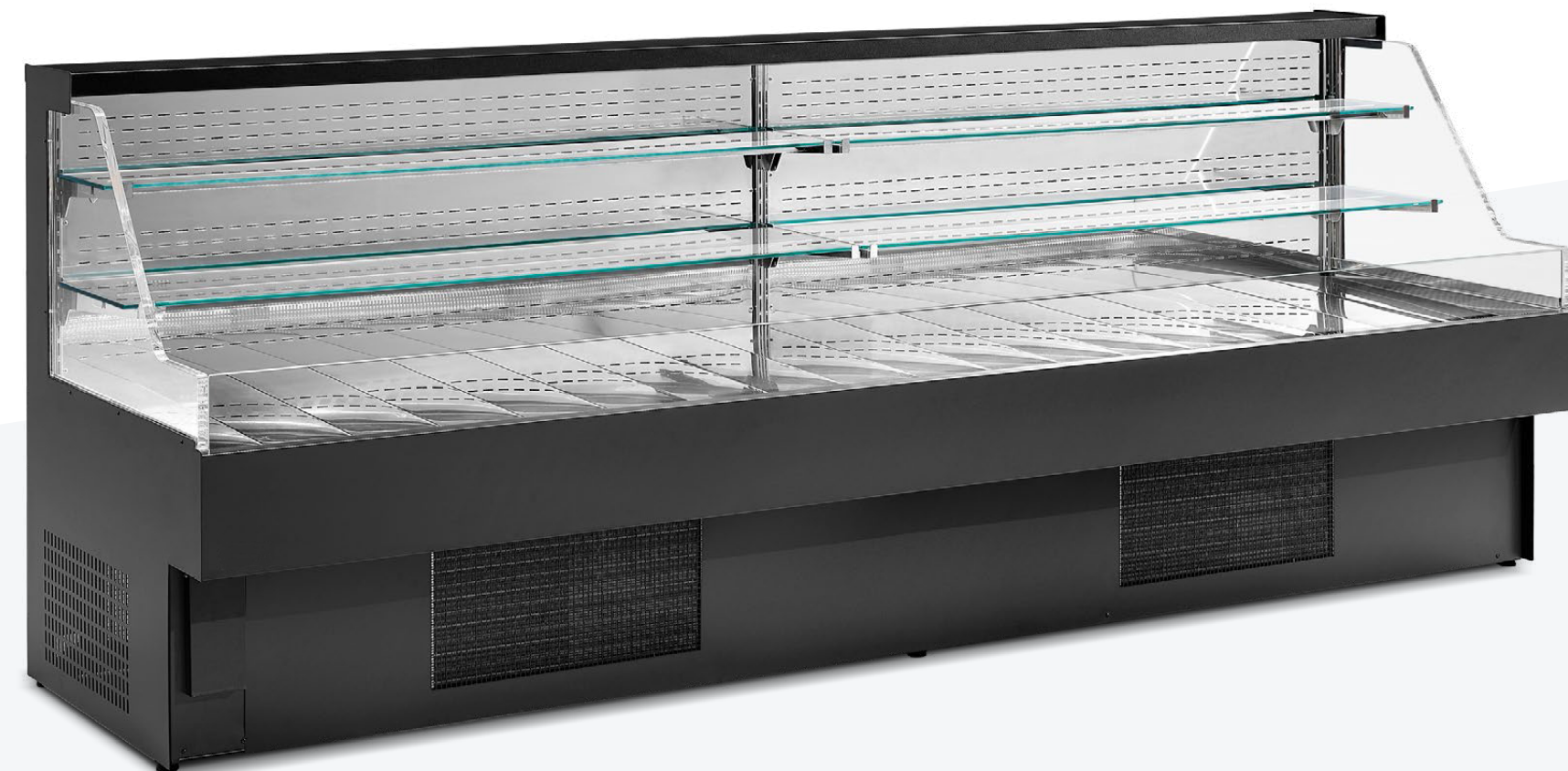



# SELF SERVICE 1

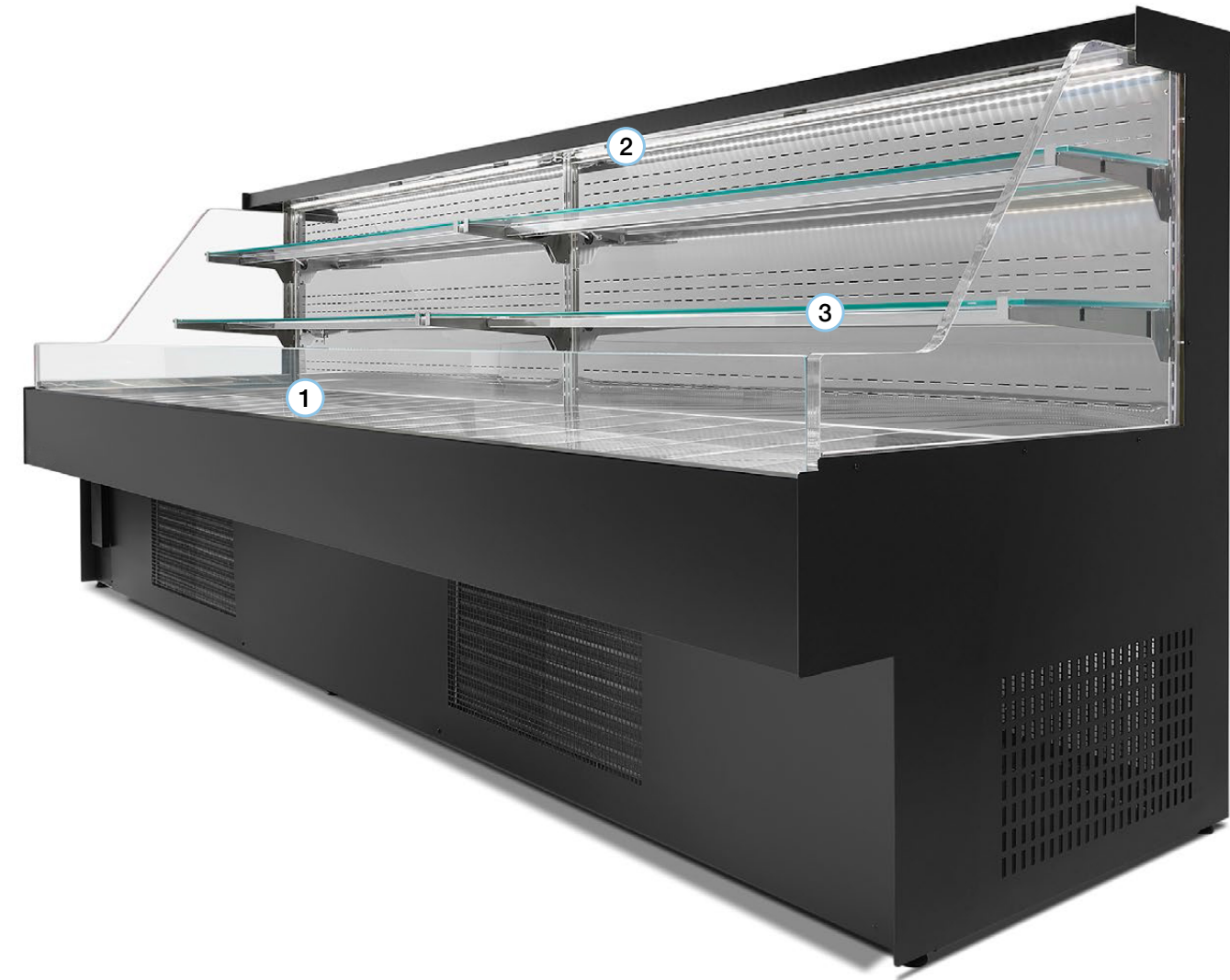

1

Zona esposizione in acciaio Inox.  
Display area in stainless steel.  
Zone d'exposition en acier inox.  
Auslagefläche aus Edelstahl.

2

Illuminazione LED su ripiani a cappello.  
LED lighting on the cap of shelves.  
Éclairage LED sur les étagères  
au plafond.  
LED-Beleuchtung an Haubenregalen.

3

Ripiani inclinabili e regolabili  
in altezza.  
Inclinable and height adjustable  
shelves.  
Étagères inclinables et réglables  
en hauteur.  
Möglichkeit von schräger und  
höhenverstellbare Fachböden.

## SELF SERVICE 1 Versions

Black

Colori spalla  
End colours  
Couleurs des côtés  
Farben für Rückwände

B-130

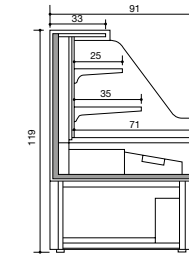

2 Ripiani  
2 Shelves  
2 Étagères  
2 Fachböden

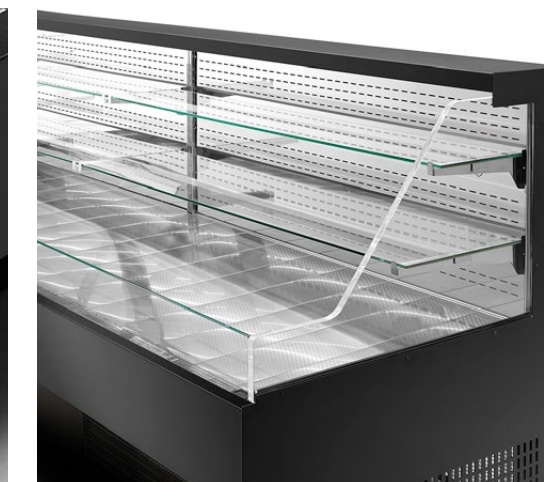



# SELF SERVICE 2



Semiverticale, totalmente efficiente.

Murale semiverticale destinato al Self-Service e studiato per l'esposizione e la vendita di sandwich, insalate, bibite e "food to go". Si presta perfettamente a essere inserito nel layout del punto vendita per creare aree promozionali.

Semi-vertical, fully efficient, is the semi-vertical wall display for self-service. Conceived for the display and sale of sandwiches, salads, drinks and food to go. Perfect to create promotional areas inside the retail area.

Semi-vertical, totalement efficace. est le présentoir mural semi-vertical destiné au Self-Service et est conçu pour l'exposition et la vente de sandwiches, de salades, de boissons et de plats à emporter. Il se prête très bien pour être inséré dans un point de vente afin de créer des espaces promotionnels.

Semivertikal, äußerst effizient. ist das semivertikale Wandregal für die Selbstbedienung und wurde für die Ausstellung und den Verkauf von Sandwiches, Salaten, Getränken und „Food to go“ entworfen. Es lässt sich perfekt in das Layout der Verkaufsstelle einfügen, um Werbebereiche zu schaffen.

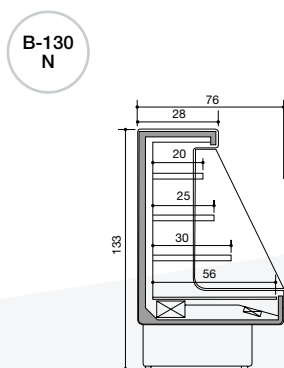

Gray **Black** Optional

Colori spalla  
End colours  
Couleurs des côtés  
Farben für Rückwände

1

Zona esposizione in acciaio Inox.  
Display area in stainless steel.  
Zone d'exposition en acier inox.  
Auslagefläche aus Edelstahl.

2

Ripiani inclinabili e regolabili in altezza.  
Inclinable and height adjustable shelves.  
Étagères inclinables et réglables en hauteur.  
Möglichkeit von schräger und höhenverstellbare Fachböden.

3

Illuminazione LED su cappello.  
LED lighting on cap.  
Éclairage LED au plafond.  
LED-Beleuchtung auf der Haube.

4

Tubo Batticarrello in acciaio Inox (Optional).  
Stainless steel bumper-rail (Optional).  
Moulure antichoc caddies en acier inox (Option)  
Stoßstange aus Edelstahl (optional).



Width in cm.

76



Length in cm.

100 · 120  
150



Climate class

3 M2  
25°C / u.r. 60%



Shelf Depth in cm.

20/25/30



Load capacity in lt.

100 = 163 lt.  
120 = 198 lt.  
150 = 252 lt.

D97 Black Version B-130 N



# SELF SERVICE 3



Width in cm.  
92



Length in cm.  
129



Climate class  
3 M2  
25°C / u.r.60%

## Modularità e grande flessibilità.

banco modulare che garantisce grande flessibilità nella realizzazione del layout, sarà molto facile e veloce cambiare il setting dell'area di vendita. Studiato per l'esposizione di prodotti come salumi e formaggi, frutta e verdure, take-away e bibite.



Modularity and great flexibility. Changing the retail area will be much faster and easier thanks the new modular counter to change the layout with great flexibility. Ideal for products such as cold cuts and cheese, fruits and vegetables, take away dishes and drinks.

Modularité et grande flexibilité. Le comptoir modulaire qui garantit une grande flexibilité dans la réalisation de l'aménagement, il sera très facile de changer rapidement la disposition de l'espace de vente. Conçu pour l'exposition de produits comme les charcuteries et les fromages, les fruits et les légumes, les plats à emporter et les boissons.

Modulare Struktur und große Flexibilität. Der modularen Theke, die eine große Flexibilität bei der Umsetzung des Layouts garantiert, ist es sehr einfach und schnell möglich, die Gestaltung des Verkaufsraums zu verändern. Entwickelt, um Produkte wie Aufschnitt und Käse, Obst und Gemüse, Take-away und Erfrischungsgetränke auszustellen.



**1**  
Zona esposizione verniciata nero.  
Black painted display surface.  
Zone d'exposition vernis noir.  
Schwarz lackierte Auslagefläche.

**2**  
Vasca raccogli condensa autoevaporante.  
Drip-pan with automatic water evaporation.  
Bac pour l'évaporation automatique de l'eau de dégivrage.  
Kondenswassersammler mit automatischer Verdunstung.

**3**  
Deflettore in plexiglass.  
Plexiglas deflector.  
Déflecteur en plexiglas.  
Deflektor aus Plexiglas.

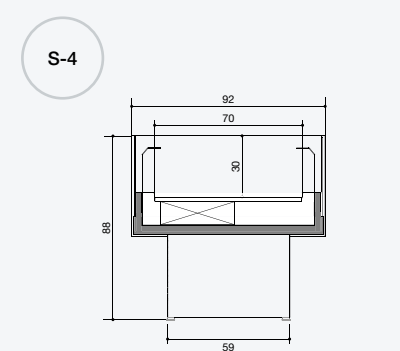

D116 Gray Version S-4

Gray Black Optional

Colori spalla  
End colours  
Couleurs des côtés  
Farben für Rückwände



# SERVE-OVER

<b>A</b>		<b>VETRO CURVO</b> APRIBILE VERSO L'ALTO
<b>B</b>		<b>VETRO DRITTO</b> APRIBILE A COMPASSO
<b>C</b>		<b>VETRO RETTO</b> APRIBILE A COMPASSO
<b>D</b>		<b>VETRO RETTO</b> APRIBILE VERSO L'ALTO
<b>Y</b>		<b>VETRO CURVO</b> APRIBILE A COMPASSO
<b>S</b>		<b>VETRO SELF SERVICE</b>

<b>1</b>	STATICO CON CELLA
<b>2</b>	VENTILATO CON CELLA
<b>3</b>	STATICO SENZA CELLA
<b>4</b>	VENTILATO SENZA CELLA
<b>5</b>	CALDO
<b>6</b>	NON REFRIGERATO
<b>7</b>	CON SUPPORTO E RUOTE
<b>8</b>	SENZA SUPPORTO E RUOTE
<b>FISH</b>	VERSIONE PER PESCE

<b>A</b>		<b>CURVED GLASS</b> OPENING UPWARDS
<b>B</b>		<b>STRIGHT GLASS</b> OPENING DOWNWARDS
<b>C</b>		<b>VERTICAL GLASS</b> OPENING DOWNWARDS
<b>D</b>		<b>STRIGHT GLASS</b> OPENING UPWARDS
<b>Y</b>		<b>CURVED GLASS</b> OPENING DOWNWARDS
<b>S</b>		<b>GLASS SELF SERVICE</b>

<b>1</b>	STATIC WITH COOL STORAGE
<b>2</b>	STATIC WITH COOL STORAGE
<b>3</b>	STATIC WITHOUT COOL STORAGE
<b>4</b>	VENTILATED WITHOUT COOL STORAGE
<b>5</b>	HOT-SECTION
<b>6</b>	NOT REFRIGERATED
<b>7</b>	WITH SUPPORT AND CASTORS
<b>8</b>	WITHOUT SUPPORT AND CASTORS
<b>FISH</b>	FISH VERSION

<b>A</b>	SPALLE A "BLOCCHI"
<b>B</b>	RIPIANI INCLINABILI CREMAGLIERE
<b>F</b>	FRUTTA VERDURA CREMAGLIERE+ SPECCHIO
<b>SG</b>	SENZA GRUPPO INCORPORATO
<b>FG</b>	SENZA GRUPPO INCORPORATO FRUTTA VERDURA
<b>VIEW</b>	MURALI CON PORTE A VETRI SCORREVOLI

<b>130</b>	H MURALE CIRCA 130 CM.
<b>130N</b>	H MURALE CIRCA 130 CM. BATTICARRELLO PLASTICA
<b>130L</b>	H MURALE CIRCA 130 CM. BATTICARRELLO INOX VETRINO FRONTALE
<b>160</b>	H MURALE CIRCA 160 CM.
<b>180</b>	H MURALE CIRCA 180 CM.
<b>190</b>	H MURALE CIRCA 190 CM.
<b>200</b>	H MURALE CIRCA 200 CM.
<b>B20 B30</b>	RETROBANCO CON BASAMENTO
<b>P20 P30</b>	RETROBANCO PENSILE DA APPENDERE O APPOGGIARE

# SELF SERVICE DISPLAY

<b>A</b>	ENDWALLS WITH BLOCKS
<b>B</b>	INCLINABLE SHELVES WITH RACK
<b>F</b>	FRIUT & VEGETABLES WITH RACK AND MIRROR
<b>SG</b>	WITHOUT BUILT UNIT
<b>FG</b>	WITHOUT BUILT UNIT FRIUT & VEGETABLES
<b>VIEW</b>	REFRIGERATED WALL CABINET WITH SLIDING DOORS

<b>130</b>	REF. WALL CABINET APROX H 130 CM.
<b>130N</b>	REF. WALL CABINET APROX H 130 CM. PLASTIC BUMPER
<b>130L</b>	REF. WALL CABINET APROX H 130 CM. INOX BUMPER & FRONT GLASS
<b>160</b>	REF. WALL CABINET APROX H 180 CM. PLASTIC BUMPER
<b>180</b>	REF. WALL CABINET APROX H 180 CM. PLASTIC BUMPER
<b>190</b>	REF. WALL CABINET APROX H 190 CM.
<b>200</b>	REF. WALL CABINET APROX H 200 CM.
<b>B20 B30</b>	BACK-COUNTER WITH LOWER STRUCTURE
<b>P20 P30</b>	BACK-COUNTER FOR HANGING OR PLACING ON LOWER STRUCTURE



# COLORI

Colori disponibili  
Available colors  
Couleurs disponibles  
Verfügbare Farben

Batticarrello  
Bumpers  
Pare-chocs  
Stoßfänger

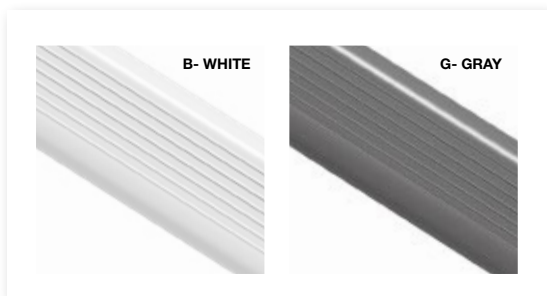
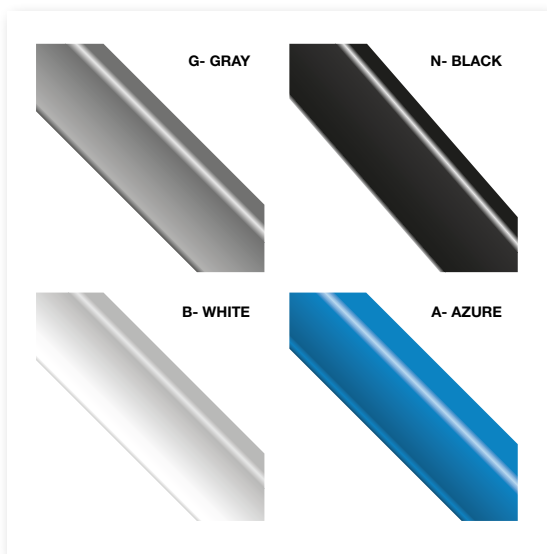

**Attrezzaturearredi  
si riserva il diritto  
di apportare ai  
prodotti le  
migliorie,  
sia meccaniche  
che estetiche,  
senza alcun  
preavviso.**

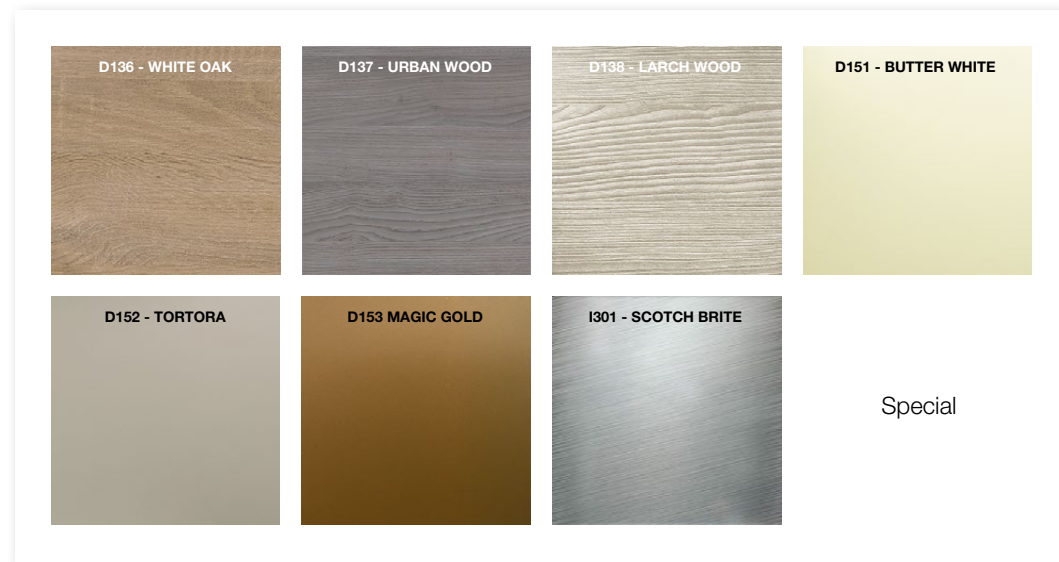
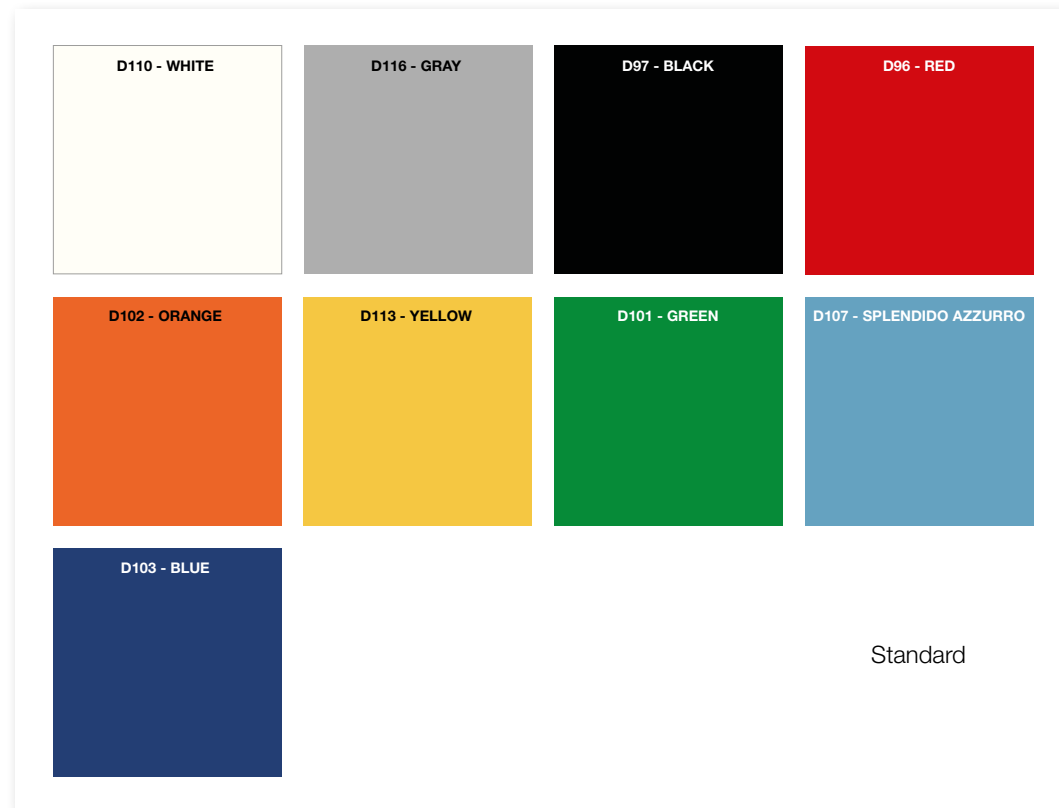



**on**

**www.attrezzaturearredi.it**

**ITALIA**

**attrezzature**  **arredi**  
EXPERIENCE EXPERTISE

Via Roberto Bronzetti, 10 - 47922 Rimini (RN)

T. 0541/1781030 - 3 LINEE R.A.

commerciale@attrezzaturearredi.it - **www.attrezzaturearredi.it**